

centra

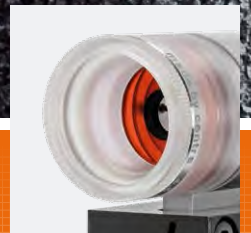

MEC

TEAMWORK

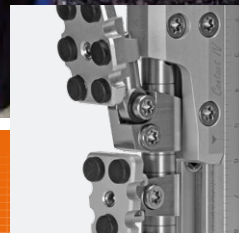
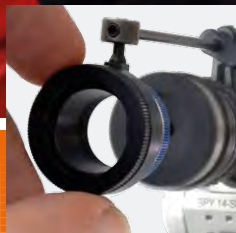

2015/16

PRODUCT CATALOGUE

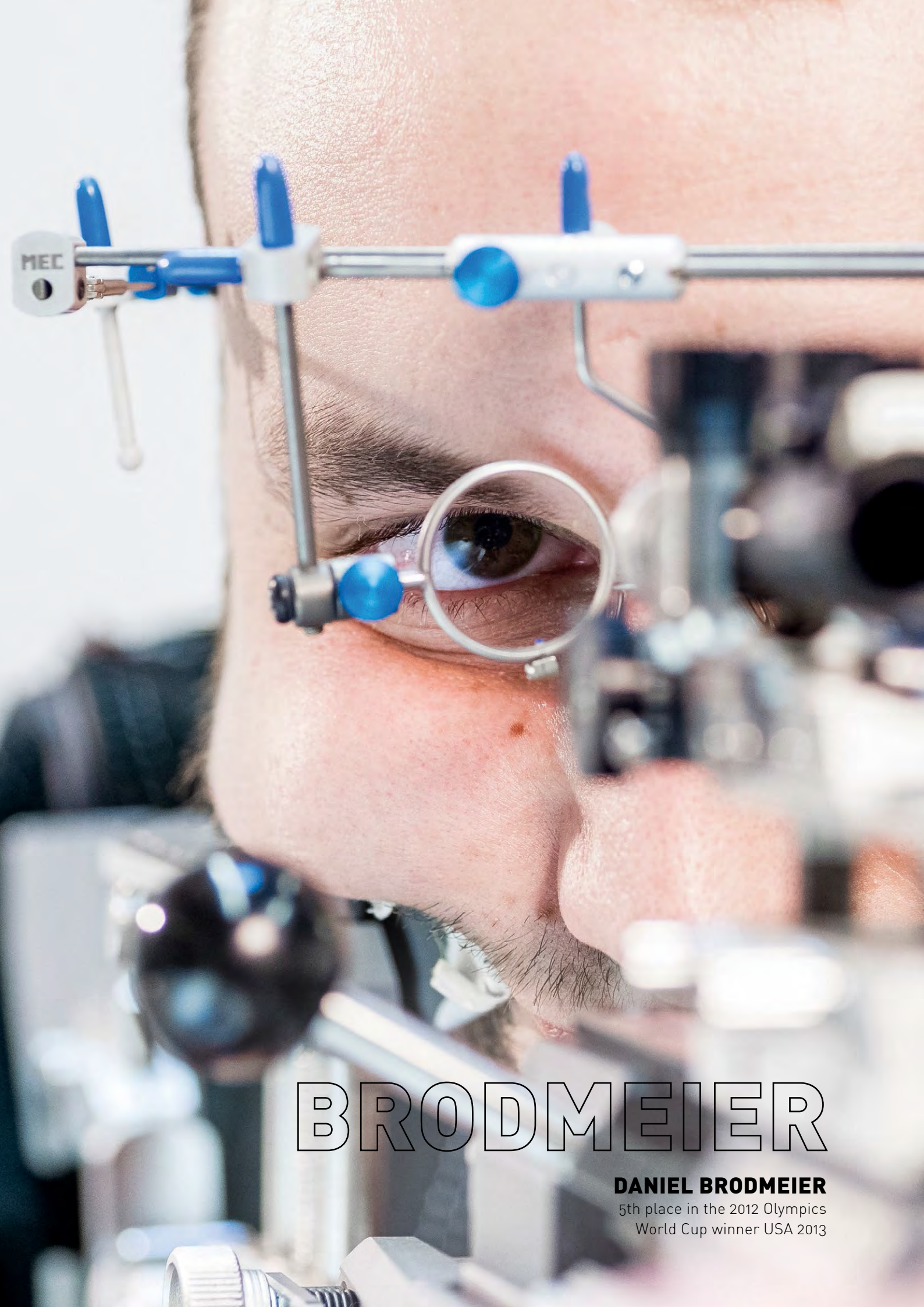

MEC

BRODMEIER

DANIEL BRODMEIER

5th place in the 2012 Olympics
World Cup winner USA 2013

TABLE OF CONTENTS

	INTRODUCTION CENTRA // MEC	4-5	
	NEW PRODUCTS 2015	6-27	
1	SIGHTS		
	Rearsights	32-35	
	Antiglare Tools	36	
	Duplex	37-41	
	Iris Apertures	42-50	
	Iris Aperture Accessories	51-53	
	Eye Covers	54-55	
	Front Sight Rings	56-61	
	Tunnels	62-63	
	Tunnel Accessories	64-69	
	Sight Shifts	70-79	
	Special Sights	80-81	
	Scope Tools	82-83	
2	SHOOTING GLASSES		
	Glasses	88-93	
	Monocle	94-95	
	Accessories	96-101	
3	MARK I STOCKS		
	Air Rifle Stocks	106-107	
	Smallbore Stocks	108-109	
	Startline Stocks	110-113	
	Mark I Accessories	114-117	
4	ACCESSORIES		
	For Rifles	122-135	
	For 3-Position	136-141	
	For Supported Shooting	142-147	
	For Pistols	148-149	
	For Everyone	150-161	
5	SCATT		
	Scatt MX-02 Universal	166	
	Scatt Sets	166-167	
	Scatt Accessories	168-170	
	Sensor Fasteners	171	
6	LITERATURE		
	English Literature	176-179	
	Other Languages	179	
7	MERCHANDISE		
	Jackets / Hoody	182-183	

INTRO CENTRA

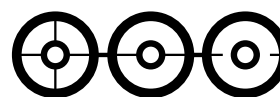

CENTRA STANDS FOR HIGH TECH SIGHTS – HANDMADE IN GERMANY.

centra is headquartered in Rheinfelden, Germany, and has built an international reputation based on its passion for perfect solutions and a proven talent for technical innovation. It all started more than half a century ago, when our company founder, Helmut Brunner, developed his first iris diaphragm in 1958.

Today, we are a state-of-the-art manufacturer that uses cutting-edge CNC and laser equipment to produce high-precision parts. However, assembly work is still carried out by hand – our team and its passion for precision and quality is our greatest asset.

What makes our company really stand out is the way we combine in-house development and production with our own personal experience of top-level sport. What's more, we work closely with the best shooters and coaches in the world. This collaboration is a constant source of inspiration and drives us to innovate and deliver high-tech products that are "Made in Germany".

Our partnership with MEC in Dortmund is founded on the personal friendship between Maik Eckhardt, Heinz Reinkemeier and myself. For us, this partnership is fundamental to the joy that we take in our "work" and it is also the foundation for our success.

It gives us great pride that we can help in some way as you pursue your chosen sport.

The centra team,
Johann Zähringer





INTRO MEC

3 LETTERS – 1 AIM: YOUR SPORTING SUCCESS!

I am a sport shooter and managing director of MEC High Tech Shooting Equipment, which is based in Dortmund, Germany. As a focused businessman, I make full use of my many years of experience in international sport to offer our customers truly outstanding products. We also have our own, successful team of shooters and work with other top athletes from around the world. As a result, we are in the perfect position to develop innovative ideas that are rooted in practical experience and result in high-end shooting equipment. All these developments are put through extensive testing at our in-house shooting range before they go into series production at precision engineering plants. Each and every product has to prove itself in training before it can be released for manufacture.

centra and MEC products complement each other perfectly. But that's not really surprising, since they are based on similar corporate philosophies – both companies give top priority to the quality and precision of their products, two things that very often decide between victory and defeat in a match.

While Rheinfelden has become the home of sight technology, here in Dortmund, we've focused on all things related to the stock. That's why it became clear that the best way to present our portfolio was to combine our ranges...

If you have any questions or requests, we're always here to help. On behalf of everyone at MEC, I'd like to wish you "good shooting" and we hope you enjoy browsing through our latest catalogue.

Maik Eckhardt,
Managing director



PRODUCT NEWS



MEC FREE SIGHT
DIOPTER K98-JR
SCORE ACCURACY / SCORE PLUS ACCURACY
SCORE COMPOSITE / SCORE PLUS COMPOSITE
ADAPTER AT
RED M22-M18
MAG M18-M22
RING AT
ADAPTER LEVEL
LENSHOOD II TRAKKER
BLOCK 6
ANSCHÜTZ TELESCOPE
KK50 4 - 12X44 A0
MEC TELE SCOPIC
REVOLVE / MEC GLAS MONOCLE REVOLVE
MEC HANDLE
CENTRA JACK / JACK LIGHT
MEC CHEEK WEIGHT
MEC PROJECT / MEC PROJECT EVOLUTION
FREE POSITION II
MEC CONTACT IV LIGHT
WINGS FOR C4 - CIV
CONTACT IV ROD EXTENSION
CONTACT IV / IV LIGHT HOLDING PLATE

MOUCHE MEC UNDERWEAR
UNIVERSAL MATCH AND SPORT TRIGGER
BLEIKER CLEANING ROD
MEC CLASSIC TIN
MEC MAT
MEC WORKBENCH MAT
LOCATOR
MEC AIR RIFLE INSPECTION TEMPLATE
TORQUE TOOL
PISTOL SHOOTING BOOK
AIR RIFLE TRAINING BOOK



MEC FREE SIGHT

Compact high-precision rearsight

- Now available in black and silver
- With new reworked clamping mechanism
- Extremely low, slim and compact
- Allows clear view over the housing, enables pre-aiming in the standing position
- Allows clear view of wind flags
- Offers approx. 20 clicks inside the air rifle 10 ring
- Includes Block 4 front sight raiser and antiglare tube, iris not included

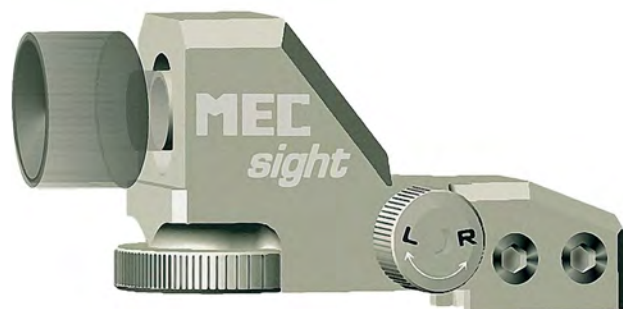

Product drawing

5030460	ANSCHÜTZ	Black
5030461	ANSCHÜTZ	Silver
5030462	WALTHER	Black
5030463	WALTHER	Silver
5030464	FEINWERKBAU	Black
5030465	FEINWERKBAU	Silver

RRP in Euros: **599.00**

DIOPTER K98-JR

Special rearsight for the Karabiner "K98"

- Left/right adjustment via side adjustment wheel
- Height adjustment via fixed iris disc (turn to adjust)
- Adjustment ranges: U/D = 2.5 mm, L/R = 3.5 mm

19010006



RRP in Euros: **198.00**



SCORE ACCURACY

Front sight tunnel with integrated bubble

- Stepless rotation around integral axle
- Reproduce various canting angles using the scale
- Colour: black/silver

M18	M22	
19913603	19913613	ANSCHÜTZ
19913604	19913614	FEINWERKBAU
19913605	19913615	WALTHER
19913606	19913616	MATCH 54
19913607	19913617	BLEIKER

RRP in Euros: 129.00

SCORE ACCURACY PLUS

- Same as Score Accuracy
- Also includes integrated sight elevation of 8 mm

M18	M22	
19913643	19913653	ANSCHÜTZ
19913644	19913654	FEINWERKBAU
19913645	19913655	WALTHER
19913646	19913656	MATCH 54
19913647	19913657	BLEIKER

RRP in Euros: 139.00



Picture shows special item High End Crystal



Picture shows special item High End Crystal

SCORE COMPOSITE

Transparent casing for maximum brightness and contrast, combined with an aluminium guide eye for increased stability.

- Stepless rotation around integral axle
- Crossbars can be inserted to check canting
- Sensational target image
- M18 and M22

M18	M22	
19913623	19913633	ANSCHÜTZ
19913624	19913634	FEINWERKBAU
19913625	19913635	WALTHER
19913626	19913636	MATCH 54
19913627	19913637	BLEIKER

RRP in Euros: 98.00

SCORE PLUS COMPOSITE

- Same as Score Composite
- Also includes integrated sight elevation of 8 mm

M18	M22	
19913663	19913673	ANSCHÜTZ
19913664	19913674	FEINWERKBAU
19913665	19913675	WALTHER
19913666	19913676	MATCH 54
19913667	19913677	BLEIKER

RRP in Euros: 109.00



ADAPTER AT

Adapter ring for the antiglare tube, used to fit additional sight elements

- For fitting Filter FS
- For fitting eagle eyes
- M18 and M22

Picture shows installation scenario with special accessories



19906324	M18
19906325	M22

RRP in Euros: 24.00

Picture shows installation scenario with special accessories



RING AT

Aperture ring for antiglare tube

19906328	M18
19906329	M22

RRP in Euros: 24.00



Picture shows installation scenario with special accessories centra Score and eagle eye



RED M22-M18

Front sight screw-in adapter for reducing M22 to M18

19906330

RRP in Euros: 29.00



Picture shows installation scenario with special accessories



MAG M18-M22

Front sight screw-in adapter for enlarging from M18 to M22

19906331

RRP in Euros: 29.00



ADAPTER LEVEL

Adapter ring for the bubble, used to fit additional sight elements

- For fitting Filter FS
- For fitting eagle eyes
- M18 and M22

19906326	M18
19906327	M22



RRP in Euros: 24.00

LENSHOOD II TRAKKER

- Antiglare tube for RPA trakker rearsight

19918820



RRP in Euros: 39.00

BLOCK 6

- 6 mm elevation
- Available only for front sight elevation

19010006	ANSCHÜTZ
19010007	FEINWERKBAU
19010008	WALTHER



RRP in Euros: 24.00



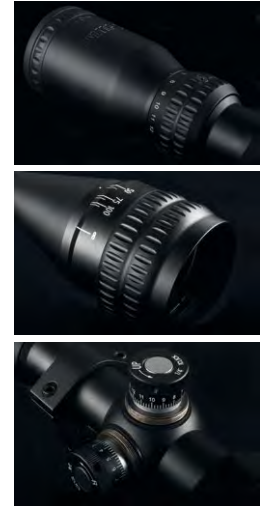
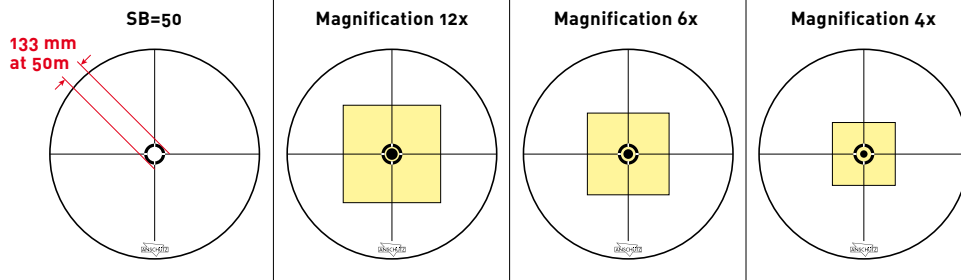

ANSCHÜTZ TELESCOPE KK50 4 - 12X44 AO

- Multicoated lenses
- 1 click 1/4 Moa, 3,65 mm to 50 m
- High Rise Mounting Rings for dovetails from 9-11 mm
- Parallax compensation from 9 m to infinity
- Weight: 582 g

19077774

RRP in Euros: 199.00

MEC TELE SCOPIC

- Rail that allows adjustment of scope position
- The rail can be tilted from 50 m to 100 m, thus minimising necessary adjustments to the scope
- Reinforces a system that has been weakened around the loading aperture
- Overall length: 250 mm
- Overall height: 30 mm
- Weight: 305 g
- Compatible with all standard match guns



5031064

RRP in Euros: 219.00



REVOLVE

- Can be retrofitted to Monocle
- Tool-free adjustment
- 360-degree rotation enables perfect lens adjustment

5028266

RRP in Euros: 98.00



Picture shows MEC Monocle Revolve on Diopter Spy.
Special items: Spy, sight 1,8 Basic with Optic and Monocle Index.



MEC GLAS MONOCLE REVOLVE

- 360-degree rotation enables perfect lens adjustment
- Tool-free adjustment

5028267

RRP in Euros: 149.00



Similar to picture.
Subject to technical changes.

MEC HANDLE

- New hand rest for supported shooting
- Can be retrofitted to all Mark I stocks
- Supports a more relaxed stance
- Reduces gun movement
- Available in 3 designs

5030968	MEC Handle KK	RRP in Euros: 198.00	
5030969	MEC Handle KK Protect	RRP in Euros: 130.00	
5030970	MEC Handle LG	RRP in Euros: 109.00	
5030971	MEC Handle LG Protect	RRP in Euros: 178.00	
5030972	MEC Handle Carbon	RRP in Euros: 143.00	

CENTRA JACK

- Finger rest for supported shooting
Hand rest for unsupported shooting
- Ergonomically shaped finger/hand rest
 - Holding elements can be individually positioned
 - Milled from solid aluminium
 - Compatible with all stocks that have a T-groove



19930006

RRP in Euros: 198.00

JACK LIGHT

- Finger rest for supported shooting
- Plastic finger rest
 - For all stocks with a T-groove



19930007

RRP in Euros: 49.00



MEC CHEEK WEIGHT

- Fitted under the Cheek cheekpiece
- Improves weight distribution
- Stainless steel

5030965	175 g	RRP in Euros: 89.00
5030966	225 g	RRP in Euros: 99.00



MEC PROJECT STOCKS WITH 2 HOLDERS THE CLASSIC IS BACK!



MEC PROJECT

- Uncompromising in production, functionality, anatomy and design
- Compatible with following systems:
 - Anschütz 1913
 - Bleiker Challenger
 - Bleiker big-bore
- Grip offers virtually unlimited movement thanks to ball joint
- Custom advice and one-off production
- Adjustable configuration

Project + Info

RRP in Euros: 2190.00



MEC PROJECT EVOLUTION

- System mount based on 2 clamping elements
- 2 adapters and various tightening torques
- Unique oscillation action
- Compatible with following systems:
 - Anschütz 1913
 - Anschütz 2013
 - Walther KK300
 - Bleiker Challenger
 - Feinwerkbau 2700
 - Grunig Racer

Project Evo + Info

RRP in Euros: 2450.00

COLOURED COATINGS

● Red / ● Blue / ● Black / ● Silver / ● Gold

ORDER INFORMATION

Please provide the following information when ordering:

- System
- Colour
- Design

MEC – project cheek piece incl. carrier

MEC – project butt plate carrier size S

MEC – project butt plate carrier size M

MEC – project butt plate carrier size L

MEC – project pistol grip size S incl. Ball

MEC – project pistol grip size M incl. Ball

MEC – project pistol grip size L incl. Ball



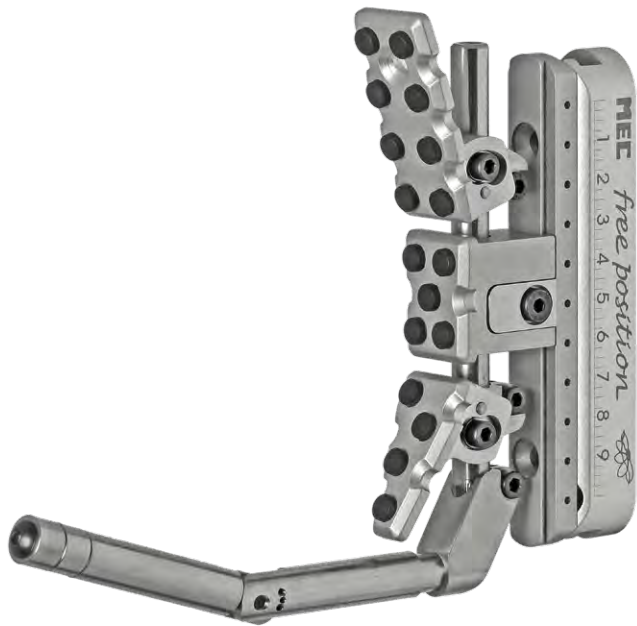

FREE POSITION II

Butt plate for Super-Match and sport guns

- Improved shape with grooving
- Steel wing holders
- Improved centre block
- Virtually unlimited adjustment options
- Wing elements allow it to be positioned up high, at an angle and support rotation around the axle
- Fits all current smallbore sport rifles

5030466

RRP in Euros: **359.00**



MEC CONTACT IV LIGHT

Reduce to the max

Compared to the Contact IV, the light version dispenses with the double joints. This greatly simplifies handling without significantly limiting the range of adjustability.

- Height adjustment is fine-tuned with a hand-operated screw
- Diverse adjustability options
- Interchangeable wings
- Perfect adhesion thank to natural rubber knobs
- Can be enhanced, e.g. with the "CIV full package"

5030605

RRP in Euros: **299.00**



Wing I

Centre

Wing II



Shows Contact IV in "Full-Package" configuration with MEC Hook.

Long holding plate

WINGS FOR C4 - CIV „FULL-PACKAGE“

Upgrade for the Contact IV and Contact IV "light"

5030611	Long holding plate	RRP in Euros: 59.00	
5030606	Wing I	RRP in Euros: 39.00	
5030607	Centre contact element	RRP in Euros: 37.00	
5030608	Wing II	RRP in Euros: 39.00	



SUPPORT

For the Contact IV Rod Extension

5030609

RRP in Euros: 34.00



CONTACT IV ROD EXTENSION

Rod extension

5030610

RRP in Euros: 29.00

THERMOUCHE SHOOTING UNDERWEAR

Shooting underwear with the double climate effect.

The first effect arises from the utilisation of the Outlast® technology where phase Change materials (PCM) are used which are able to take up warmth, store it and release it again to achieve an optimum moisture and temperature management.

The second climate effect occurs from the sandwich construction of the warp knitted fabric. Two layers of fabric, held by monofilament threads at a distance, form an insulating layer of approx. 1.5 mm thickness. This serves at the same time as a rallying buffer for perspiration.

The undergarment is responsible for the microclimate beneath the thick, barely breathable shooting clothing. When the body temperature rises due to overheating, it can also increase the pulse rate and blood pressure of the shooter and besides, affects negatively the eyesight. Thermouche with PCM technology is the only material that can cool the body actively. The shooter is not so hot, so he is perspiring less, but all the sweat vapor is distributed in the insulating layer and the skin and the thermouche underclothing feel dry.

Characteristics:

- Thermo regulation: Keeps the body cooler in hot weather and warmer in cold weather
- breathable and perspiration regulating
- Unbeatable good fit, almost wrinkle-free in all shooting-positions
- Machine washable - dries quickly
- Odorless
- Pleasant, visually beautiful flat seams that do not cause pressure or chafing at seam intersections

Fabric:

Fabric 1: 87 % Polyester (PES) / 13 % cotton (CO)

Fabric 2: 98 % Cotton (Co) / 2 % Elastane (EL)

Care:

Machine wash at 30 degrees, no tumbler, dry hanging or lying

Colour: white / blue

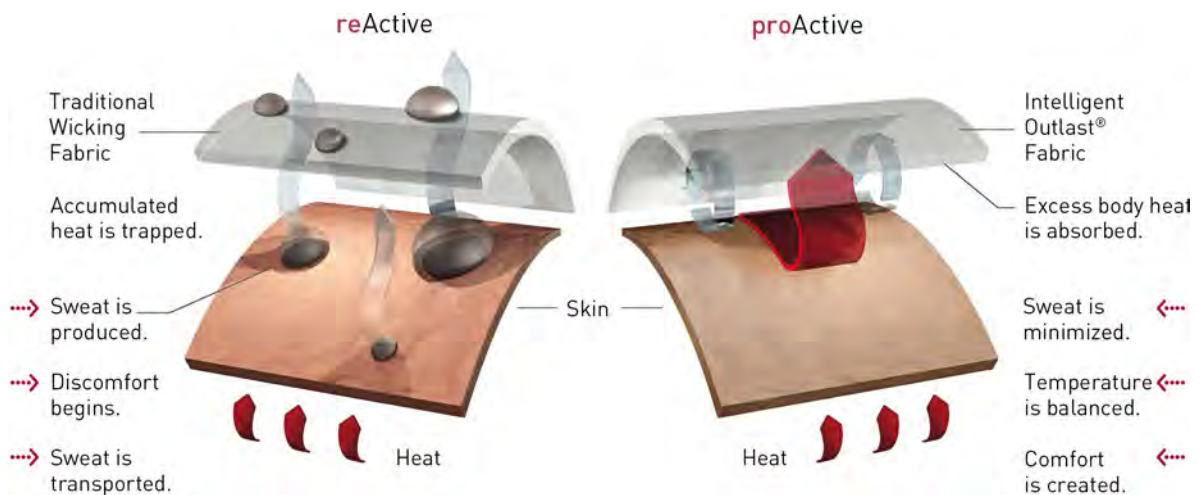



SWEATER THERMOUCHE

- Double layer as padding for the elbows, as well as the upper arms
- 2-way zipper
- The neck closed higher by stand-up collar
- Thin stretch in the crooks of the arms

5030697	Size XS
5030698	Size S
5030699	Size M
5030700	Size L
5030701	Size XL
5030702	Size XXL

RRP in Euros: **167.00**



LEGGINGS THERMOUCHE

- Higher cut in the back for kneeling position
- Lateral stretch stripes for better fit
- Thin stretch in the knee bends
- Waist elastic secured against twisting

5030703	Size XS
5030704	Size S
5030705	Size M
5030706	Size L
5030707	Size XL
5030708	Size XXL

RRP in Euros: **86.00**

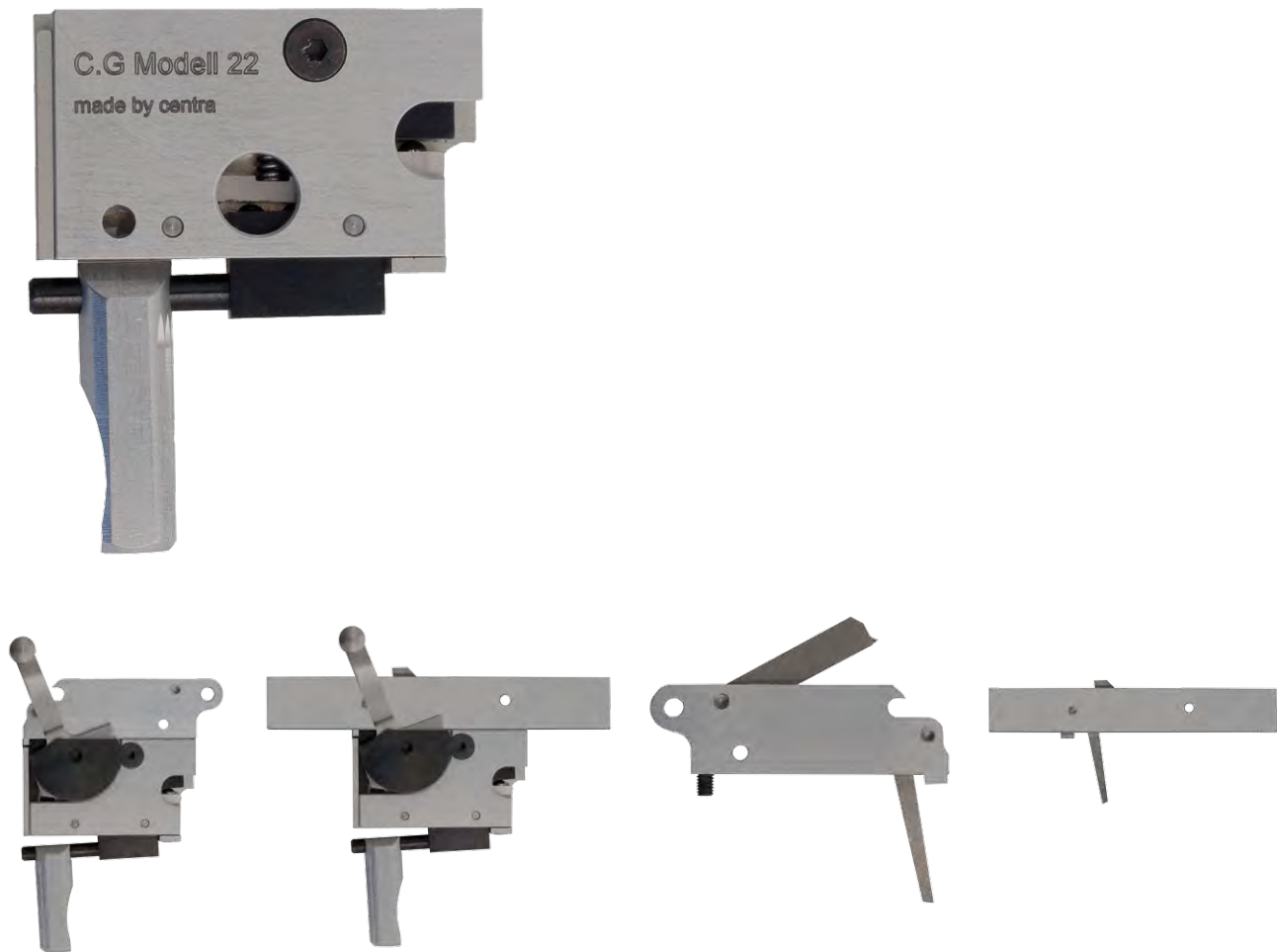

C.G. MODELL 22 UNIVERSAL MATCH AND SPORT TRIGGER

The C.G. Modell 22 "Universal" Trigger has been designed by Robert Chombart

- Based on a common mechanism we call the Main housing, which is attached to Upperframes that are appropriate to the various modes of action that the C.G. 22 trigger is designed to support.
- True 2-stage trigger can be easily set for single stage
- CNC machined with wire EDM-cut tool steel levers, treated to 58-60 HRC
- Suitable for all fullbore competition pull weights

19T0000	Mainhousing	RRP in Euros: 160.00	
19T00002	Mainhousing with safety	RRP in Euros: 238.00	
19T00003	Mainhousing with bottomsafety	RRP in Euros: 229.00	
19T00004	Upperframe Rem 700	RRP in Euros: 140.00	
19T00005	Upperframe Tikka-Sako	RRP in Euros: 89.00	
19T00006	Upperframe Swing-Paramount	RRP in Euros: 89.00	
19T00007	Upperframe Barnard „P“	RRP in Euros: 89.00	
19T00008	Upperframe Mauser 98	RRP in Euros: 100.00	
19T00009	Upperframe Accuracy Intl	RRP in Euros: 89.00	



GUIDE BLEIKER

Cleaning rod

- Prevents damage to chamber
- Protects your trigger mechanism from dirt and cleaning agents
- Synthetic

19C00203

RRP in Euros: 29.00



MEC CLASSIC TIN

- Metal tin
- Sandblasted look in silver
- Suitable for safely transporting the MEC Eagle Eye Change

- Also suitable for other small parts such as the Duplex-Insert

5001033

RRP in Euros: 8.50

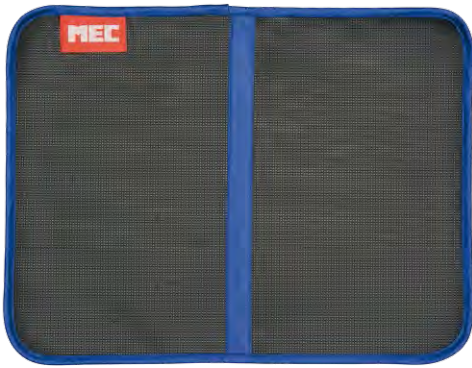

MEC MAT

Stops gun, tool or ammunition from slipping and sliding when put down. Protects your gun from damage. The central reference stripe helps to improve your perception of the target when building up your position.

- Approx. dimensions: 43 cm x 33 cm
- One side smooth, the other semi-perforated

- Non-slip effect on both sides
- Target orientation stripe courtesy of Heinz R.
- ISSF compliant

5030626

RRP in Euros: 19.90



MEC WORKBENCH MAT

Gun workbench mat with semi-perforated coating and non-slip effect on both sides. Stops guns, gun parts, accessories and tools from slipping and being damaged during change-over and maintenance work. Also ideal for mobile use.

- Dimensions: 160 cm x 80 cm
- Semi-perforated coating
- Non-slip effect on both sides
- Drop protection

5030604

RRP in Euros: 79.00

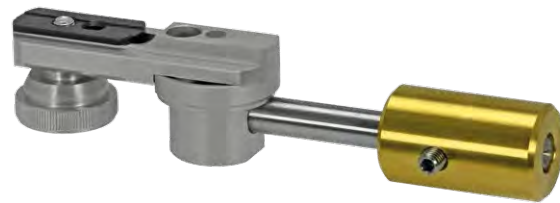

LOCATOR

Mounting and adjustment unit for the SCATT aiming trace analysis system

- Fastens to the T-slot rail on the stock
- X/Y adjustment unit ensures the SCATT sensor can be accurately lined up with the target
- Axis displacement can be blocked

- The adjustment unit can be detached from the carrier rod and replaced with the additional weight included in the scope of supply. This ensures the gun has exactly the same weight and balance as when SCATT is mounted.

19400004

RRP in Euros: **249.90**

MEC AIR RIFLE INSPECTION TEMPLATE

5018898

RRP in Euros: **52.00**



TORQUE TOOL II

Torque wrench

- Adjustment range from 3 to 15 Nm
- Supplied with shank bits in the following sizes:
 - 3, 4, 5, and 6 AF
 - Torx T25 and T30

19A1101

RRP in Euros: **99.00**



THE AUTHORS OF YOUR SHOOTING-BOOKS PUBLISHER MEC



HEINZ REINKEMEIER, psychologist, coach and designer. He is the author of 7 books on shooting, has made several educational films and published articles in various specialist journals.



GABY BÜHLMANN, psychologist and rifle coach. European air rifle champion 1997. Participated in five Olympic Games as an athlete in 1988 – 2004. Italian rifle coach working with Nicco Campriani, Valentina Turisini and a number of other successful shooters.

heinz reinkemeier



Further information is available at:
WWW.HEINZREINKEMEIER.DE

OLIMPIJSKIE KONKURENCJE PISTOLETOWE BOOK

Heinz Reinkemeier, Gaby Bühlmann

All you need to know about the sport of pistol shooting. 220 colour pages containing 1,200 up-to-date photos, illustrations and graphics. Photographs of most top international athletes, plus in-depth studio shoots with Olympic and world champions. Contributions from German national coaches Peter Kraneis and Barbara Georgi and 14 other outstanding trainers and shooters from around the world. Covers the latest topics such as the German Bundesliga, youth training, electronic trainers, ammunition testing, mental training, coaching...

ISBN 978-83-928836-3-0

Polish edition!

5031060

RRP in Euros: 49.90

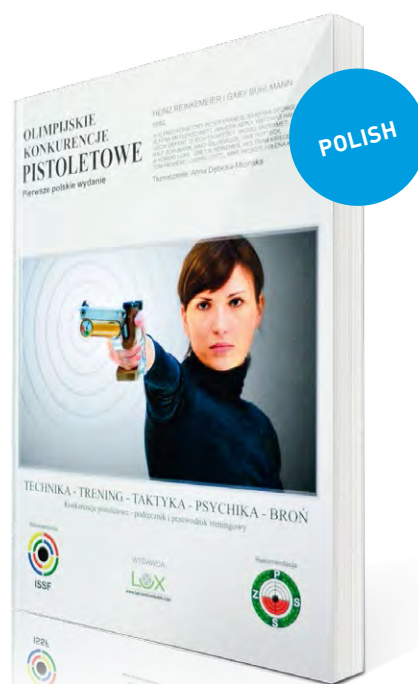

AIR-RIFLE TRAINING & COMPETITION BOOK

New edition!

Bühlmann & Reinkemeier.

This book focuses primarily on 10 metre air rifle shooting, but also covers three-position shooting and supported shooting. Contains everything you need to know about air rifles in a compact but comprehensive format.

English translation by Linguatext Ltd.

5026103

RRP in Euros: 49.90



HIGHEST PRECISION

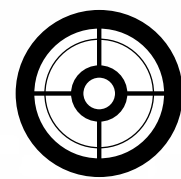

1 SIGHTS

- ⊙ REARSIGHTS
- ⊙ ANTIGLARE TOOLS
- ⊙ DUPLEX
- ⊙ IRIS APERTURES
- ⊙ IRIS APERTURE ACCESSORIES
- ⊙ EYE COVERS
- ⊙ ADJUSTABLE FRONT SIGHT RINGS
- ⊙ FRONT SIGHT RINGS
- ⊙ TUNNELS
- ⊙ TUNNEL ACCESSORIES
- ⊙ SIGHT SHIFTS
- ⊙ SPECIAL SIGHTS
- ⊙ SCOPE TOOLS

1

2

3

4

5

6

7

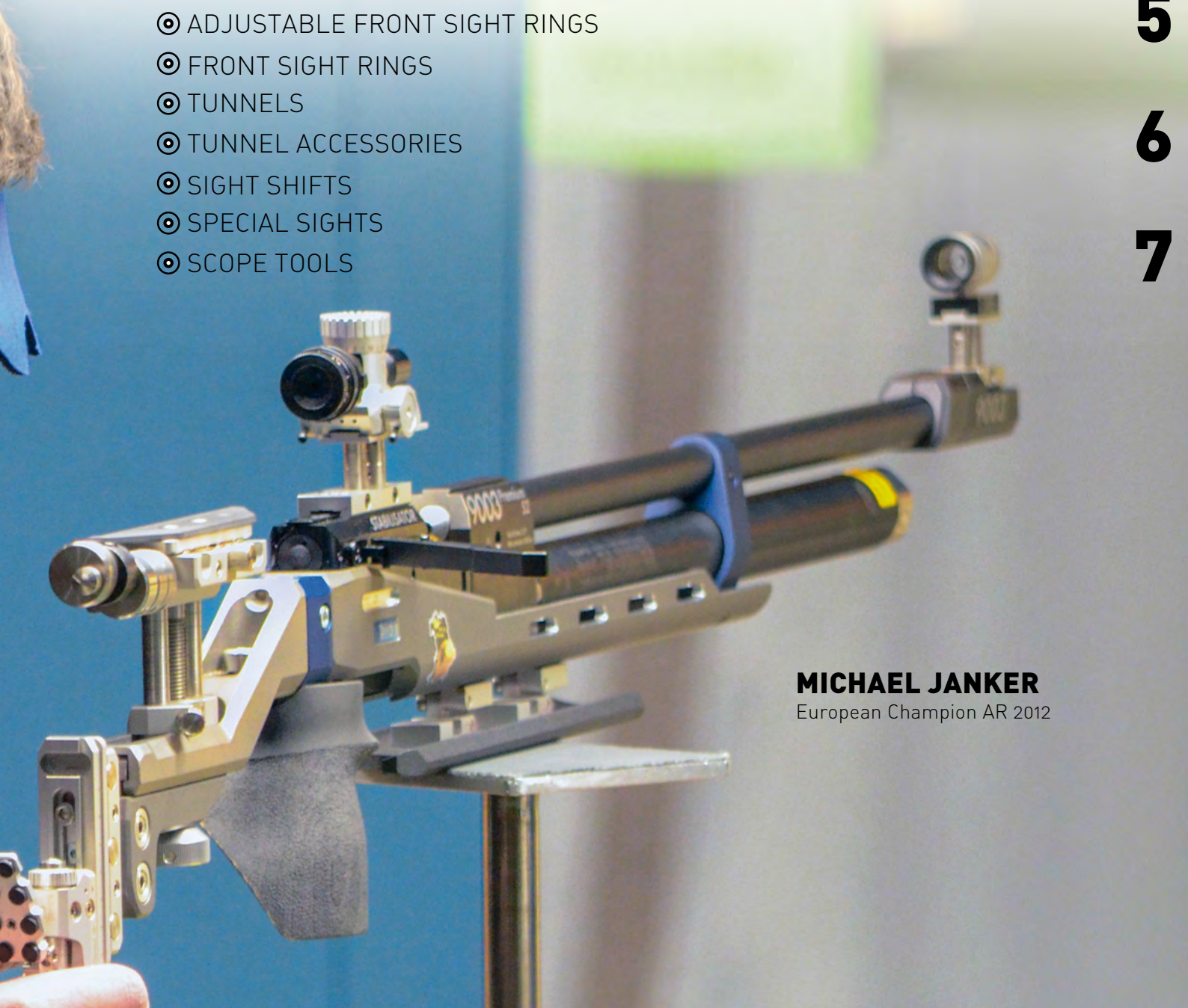

MICHAEL JANKER
European Champion AR 2012

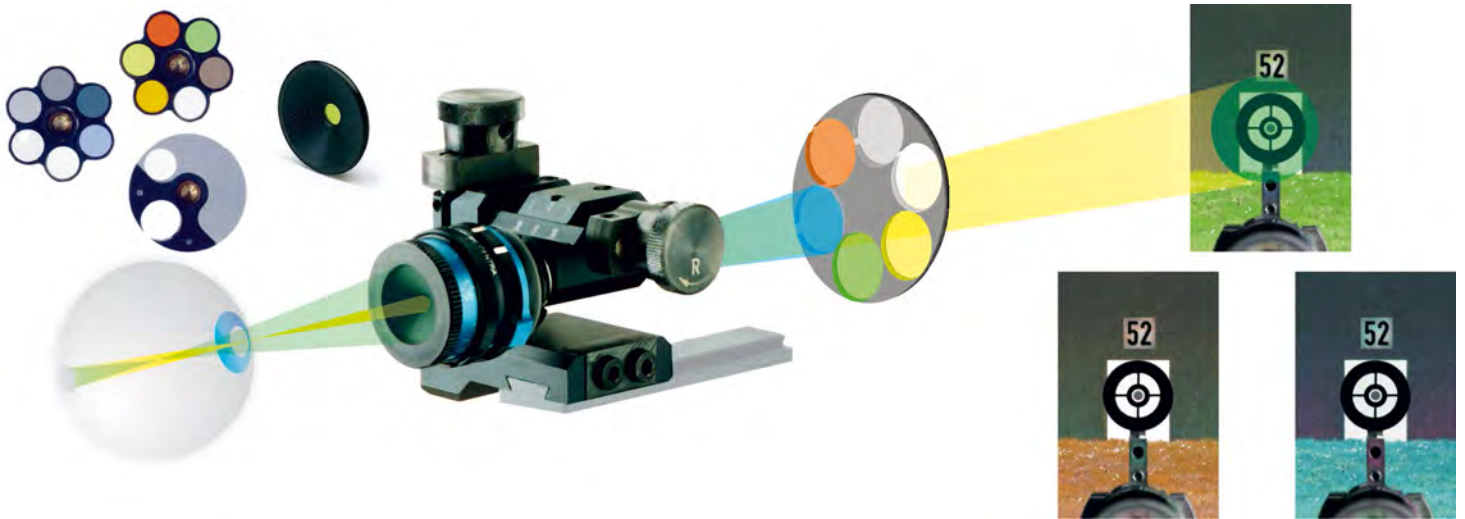

COLOUR FILTERS

While fine-tuning your iris diaphragm helps to “sharpen” the target image, the right choice of filters will significantly improve contrast. The colour and coating on a filter will block certain spectral ranges – beams of specific wavelengths – as light passes through them. Depending on the properties of the filter lens, a filter will make the target image appear e.g. yellow, green or red (on a subjective basis).

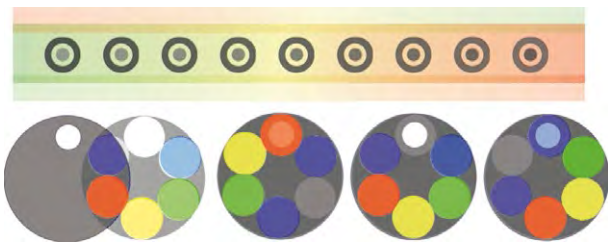

This has a number of consequences:

1. Filters remove certain colours from the image and enhance others. Depending on the colour of the light, this changes contours and often improves contrast.
2. The resultant colouring usually has a subjective, emotional effect on the observer. Green is said to be calming, while red is associated with a stimulating effect.
3. In objective terms, there is evidence that filters improve a shooter’s perception of the target under certain conditions.

For example, you might find that you can see better under certain cloud conditions or in the evening light, because certain spectral ranges are being naturally filtered out. Artificial filters can intensify the target image and improve contrast in the same way. Indeed, our coloured lenses are designed to reproduce this effect on a systematic basis. There are also grey inserts and polarisers that can be used to reduce the amount of light, if necessary, and eliminate reflections.

If the result is unsatisfactory (too bright or poor contrast), that is when the filters come into play. If the target is too bright, you should start by testing the grey, C41-blue and brown filters. If the Sun is shining directly on the target, it is always a good idea to try out the brown filter.

In extremely bright conditions, you can combine it with grey levels or the polarisation filter. When trying to deal with such extreme situations, it can be helpful if your fixed/variable iris has two coloured filter wheels, one behind the other, so that two filters can be switched in series. Ideally a fixed iris should also have a polarisation filter.

A tip from the coach:

How to adjust the iris aperture and choose the right filters: When making adjustments, you should start off by looking at the target without any filters.

1. Adjust your iris aperture to its maximum size
2. While aiming at the target, slowly close the iris aperture until the front sight appears in perfectly sharp focus. Take a reading from the scale for the iris diaphragm
3. Adjust your iris aperture to its minimum size
4. While aiming at the target, slowly open the iris aperture until the front sight again appears in perfectly sharp focus. Take a reading from the scale for the iris diaphragm
5. Now adjust your iris aperture to the average of those two readings

TRAINER TIP



- 1
- 2
- 3
- 4
- 5
- 6
- 7

Centra has spent more than half a century researching and experimenting with light regulation **and is continuing to do so**. The result of all this work is a wide range of unparalleled high-precision optical instruments. Our latest development in the field of light regulation is our **Sight 1.8 Super AR** series of iris diaphragms. While our tried-and-tested, state-of-the-art precision iris diaphragm with 15 discs continues to deliver top performance in these products, the filters represent a leap forward in progress. All the filters feature a special **UV-400 coating** designed to eliminate the UV radiation that is perceived as glare. However, the real advance is the **super anti-reflection coating** on the filter lenses, which helps ensure maximum quality and transmission. This treatment improves light transmission significantly by up to 8 percent and prevents troublesome reflections.



OUR RECOMMENDATION:

Sight 1.8 Super AR II, 1.8 Twin, 1.8 Competition.

In cloudy, rainy, foggy or misty conditions, you can use contrast-enhancing filters: yellow, peach, orange, green, C41-blue, UV 400. Everybody’s eyes are unique, which is why everyone responds differently to varying intensities of light. It simply isn’t possible to formulate standard rules that apply across the board – using filters requires concentration and experience in trying out different approaches.

A tip from the coach:

The ideal time to adjust your sights is before you start taking sighting shots. Sit down at your firing point, get yourself comfortable and rest your rifle on a kneeling roll, then adjust your iris diaphragm, filter and the proportions of your front sight until you like what you see. When taking your sighting shots, you should only need to make minor adjustments.

After inserting or changing a filter, you must check your iris aperture and the diameter of your front sight. As a rule of thumb, you should find that you will need to enlarge your iris aperture and front sight when using a darker filter.

Interchangeable filters must be of the very highest quality. Only pure, perfectly ground glass will allow light to pass through it without any noticeable refraction, particularly in the case of the **Super AR lenses with a super anti-reflection coating**. This guarantees a clear view and stops your point of impact from moving when changing lenses.

Shooters are responsible for keeping their filters clean. Dust, humidity and temperature changes should be avoided, as they can cause cloudiness in the lenses. A filter insert should be thoroughly cleaned once a year.

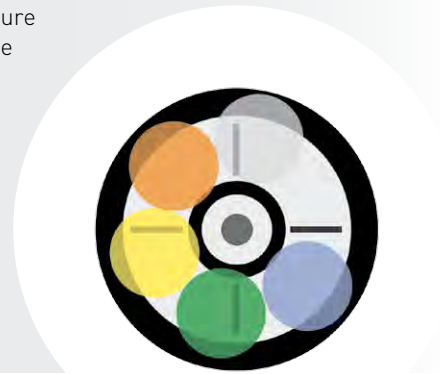

FILTERS IN THE FRONT SIGHT TUNNEL

The vast majority of competitions are held using electronic scoring targets. These targets are extremely bright and often lit up from the inside, which means they produce very strong contrasts that our eyes have great difficulty processing. The mistake that shooters make most often in this regard is to try and reduce extreme brightness using dark grey filters near the iris diaphragm. This darkens the iris aperture, making it difficult to centre the front sight tunnel accurately. Every tenth counts, and we have therefore developed the **Polarizer single** and **Polarizer double** to tackle precisely this problem.



These filters darken the view through the front sight tunnel in order to counter the extreme brightness of the target while leaving the gap between the front sight tunnel and iris aperture bright, which is ideal for accurate centring.

In addition to polariser filters for dimming light, we have also developed contrast-boosting filters for the front sight tunnel – **Filters FS**, which also have a centre hole. In tricky light conditions, “secret weapons” like these can make all the difference.

For example, during one particular German Championship, the range at Munich-Hochbrück was shrouded in fog. Men, 60 prone, 8:00 a.m. We had just developed the **Filter FS** and two experts were using “the yellow”. One of them became German Champion and the other was runner-up – Maik Eckhardt and Johann Zähringer.

SPY CROMO BUILT TO LAST!

Every product we manufacture is made for more fun, more success and better results. A great deal of careful, high-precision work goes into our equipment, which is designed specifically for shooters who are aiming for the best.

The "Spy Cromo" is fashioned from a combination of exceptional materials. The chassis is made from stainless steel, while the tower – the core element for height

adjustment – is made of titanium. Titanium is a very special material that delivers enormous tensile strength but is still light in weight. For example, when shooting a big-bore gun and 6 mm BR from 300 m, the rear-sight is subjected to severe stresses and acceleration. That is why we developed a high-strength chassis and lightweight tower combination that can easily withstand such punishment. You only need hold it in your hands to realise the mechanical qualities and high-end build of this rearsight.



Optional accessory:
Duplex Vario



View from
above

SPY CROMO

- 24 clicks (0.02 mm per click)
- 0.2 mm per click at 10 m
- 1 mm per click at 50 m
- 2 mm per click at 100 m
- 6 mm per click at 300 m
- Includes anti-glare tube for accommodating additional sight elements such as duplex inserts, coloured filters and polarisers.

19088894	ANSCHÜTZ
19088895	FEINWERKBAU
19088896	WALTHER

RRP in Euros: **800.00**

REARSIGHTS



SPY SHORT



Rearsight with an additional centring unit - an innovation!

- Extremely slim and compact
- Additional centering-unit for more precise aiming
- Better balance in standing position thanks to clear spatial perception
- Gives free view of the wind flags
- Colours: silver (Si), black (S)

19088881 + colour	ANSCHÜTZ
19088882 + colour	FEINWERKBAU
19088883 + colour	WALTHER

RRP in Euros: **459.00**



SPY LONG



Same as Spy Short "ID"

- Extra long chassis
- 2 clamps for fixing
- Also for big bore
- Colours: silver (Si), black (S)

19088884 + colour	ANSCHÜTZ
19088885 + colour	FEINWERKBAU
19088886 + colour	WALTHER

RRP in Euros: **459.00**



SIGHT BASE 10 – 50

Rearsight for 10, 50 and 100 metres

- Identical structure like Sight Base "LR", however with polished finely threaded spindles
- Improves wind observation
- Fits for all current match-rifles
- 1 click to 10 m are 0.25 mm
- 1 click to 50 m are 1.22 mm
- Weight: 200 g

19010001-F	ANSCHÜTZ
19010002-F	FEINWERKBAU
19010003-F	WALTHER
19010031-F	REDFIELD

RRP in Euros: 419.00



SIGHT BASE LR

Special long range rearsight

- Polished, stainless steel, ball-bearing mounted precision threaded spindles
- Movable scale for zero point adjustment
- Including one locatorring
- Weight: 200 g

left thread	right thread	
19010001	19010002	ANSCHÜTZ
19010011	19010012	WEAVER
19010021	19010022	PARAMOUNT
19010031	19010032	REDFIELD
19010041	19010042	CENTRAL

RRP in Euros: 419.00



FRONT BASE LR

Adjustable front-sight for lang-range

- Polished, stainless steel, ball-bearing mounted precision threaded spindles
- Movable scale for zero point adjustment
- Including one locatorring
- Weight: 95 g

19920018	M18
19920022	M22

RRP in Euros: 330.00

19920019	Locator ring sep.
----------	-------------------

RRP in Euros: 37.00



PRO 57 STARTLINE

- Highly rigid aluminium
- 20 clicks, 0.2 mm at 10 m
- Suitable for all current competitions rifles

19010005

RRP in Euros: 189.00

OUR NEW PRODUCT

MEC Free Sight can be found on page 8.

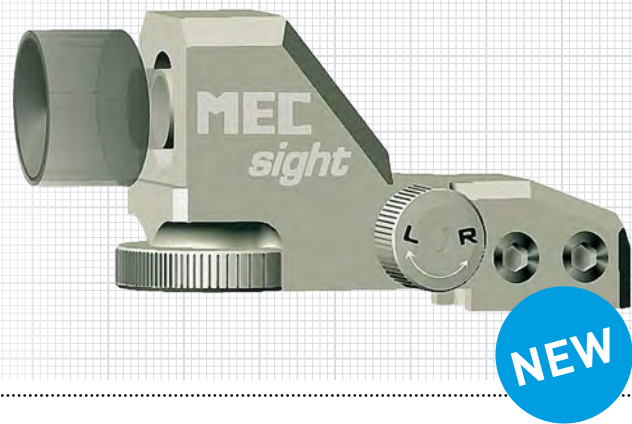

ANTIGLARE TOOLS

LENSHOOD

- Antiglare tube shades out scattered light from the front

19918808

RRP in Euros: 38.00



LENSHOOD POL

- Antiglare tube with polarising filter
- Reduces reflection and mirage effects

19918809

RRP in Euros: 75.00



POL LENS

- To eliminate reflections
- Two polarizer-discs to adjust the sight-picture for optimum contrast
- Additional female thread to mount coloured glass inserts

19918810

RRP in Euros: 51.00



Shows optional extras
Diopter Spy Short,
Sight 1,8 Tiny

LENS

- Easy to clean
- Excellent optical characteristics



Shows optional extra
Diopter Spy Short



19904011	Light Gray	
19904012	Gray	
19904013	Dark Gray	
19904014	Brown	
19904015	Green	
19904016	Yellow	
19904017	Orange	
19904018	C41 Blue	
19904019	C41 UV	
19904020	C41 Peach	

RRP in Euros: 27.00

DUPLEX

Aiming with micrometre peep sights and a front sight tunnel is an almost perfect solution. But even nearly perfect solutions can still be improved. In competitive sports, every point counts. Indeed the tolerances are tiny, particularly while aiming, when the front sight can become misaligned with the iris aperture. In fact, if the front sight is not perfectly centred in the iris aperture, the shot will miss the bullseye.

Shooters have to take the utmost care not to make a mistake like that. They need to make sure their eye is centred precisely on the rearsight iris on each and every shot. However, that is a very difficult thing to do, especially in challenging light conditions and over the course of long series.

The "Duplex" is an additional centring unit that doesn't place any extra demands on a shooter's concentration. The intermediate ring that it produces gives the eye an extra point of reference that provides a clearer indication of an alignment error. Integrating this additional ring concentrically into the sighting line was a real challenge.

The result is an X-Y adjustment-unit, the Duplex. Technology made by MEC & centra! When every tenth counts, the Duplex is the answer. The logical extension to the Duplex is the Duplex-Vario.

The centring ring is now variable and can be adjusted to suit personal requirements. Two adjustment ranges are available. The 3.4 – 4.4 range has been developed for rearsights with short anti-glare tubes, such as the SPY and FREE-SIGHT. The 3.8 – 4.8 range, meanwhile, is intended for use with rearsights that have long anti-glare tubes, such as Anschütz and FWB models.

The size of the centring ring should ideally be adjusted so that the light space [gap] between the iris aperture and the centring ring is relatively small. That way, the tiniest misalignments are immediately apparent and your

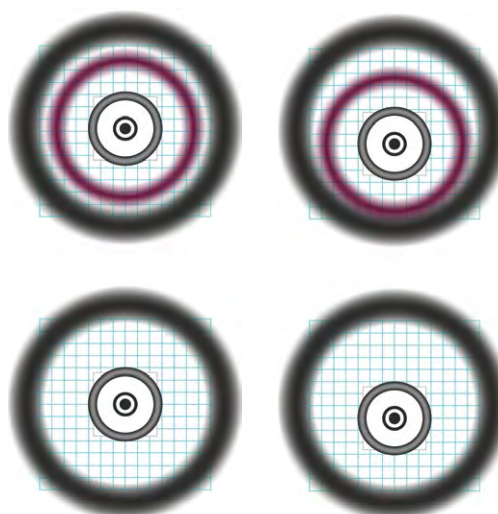

aiming becomes significantly more precise. If you need to readjust your iris aperture due to changing light conditions, or if you put a filter in place, you can also alter the adjustable centring ring of the Duplex-Vario to match – just as on an adjustable front sight ring. It is a solution that is convenient, but absolutely uncompromising. The alternative to the centring ring – whether a variable model or as a fixed Duplex-Insert – is the "Duplex-Iris". As a stepless adjustment system, it allows you to modify the gap between the front sight tunnel and iris aperture as required. If you close the Duplex-Iris so much that only a very narrow strip of light is visible around the front sight tunnel, you will be able to see every tiny aiming error.

The Duplex-Iris is a popular choice among indoor air rifle shooters. We recommend the Duplex-Vario for outdoor shooters who fire from 50 m and 100 m and who will benefit from having a clear view of wind flags and other indicators.

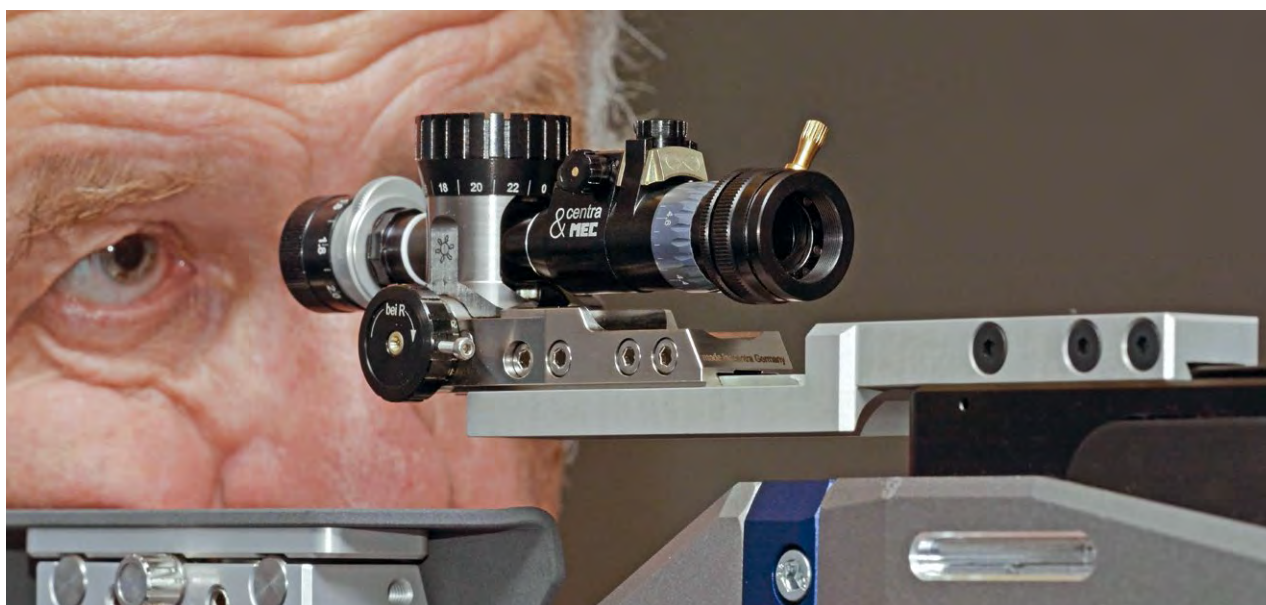

X-Y adjustment-unit to allow the attachment of an additional centring ring or iris

- Significant improvement of the aiming accuracy
- Minimises aiming errors
- Allows the attachment of individual centring ring sizes or an centring iris
- Individual adjustment of centring ring (iris) distance using stepless length shifts on the lens shade
- Compatible with the centra rearsight "SPY" and in combination with "Lenshood II" (MEC Free Sight, centra Sight Base, FWB rearsights and older Anschütz rearsights)



Shows Duplex on rearsight Spy long incl. optional extra Duplex Insert, Sight 1,8 Tiny



Shows optional extra Duplex Insert



DUPLEX

1940002

RRP in Euros: **149.00**



Colours may vary from those shown.

DUPLEX VARIO

XY adjuster with integrated adjustable centring ring

- Adjustable centring ring
- Can accommodate an additional duplex iris
- Can accommodate a coloured filter (lens)
- 2 adjustment ranges available 3.4 - 4.4 and 3.8 - 4.8

1994005	3.4 - 4.4
1994006	3.8 - 4.8

RRP in Euros: **249.00**

OUR NEW PRODUCT

Lenshood Tracker can be found on **page 11**.

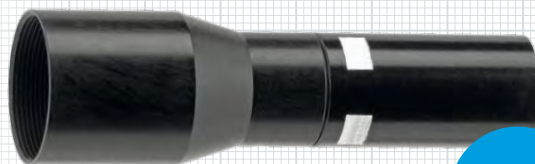

NEW



Shows Duplex Insert in the colour clear with optional extra Duplex



DUPLEX INSERT

- Centered ring insert for DUPLEX
- Individual size selection from 3.8 – 4.2

Diameter
3.8 = **38**
4.2 = **42**

1	9	4	3	3	8	1	3	C
---	---	---	---	----------	----------	---	---	----------

+ Colour
C = Clear
Y = Yellow

Clear: **RRP in Euros: 22.50**

Yellow: **RRP in Euros: 33.00**



Shows optional extras Duplex, rear sight Spy and Sight 1,8 Tiny



DUPLEX IRIS

- Iris-insert for Duplex
- Possibility to reduce the light between front-sight-tunnel and iris-hole completely

19940003

RRP in Euros: 62.00



LENSHOOD II

- Antiglaretube fits at centra Sight Base, MEC Free Sight, Feinwerkbau-rearsights and old Anschütz-rearsights
- Possibility to mount Duplex, Lens, Lens-Pol
- See **pages 40-41** for information on placing orders

RRP in Euros: 38.00



COLLIMATOR

- Ball-and-socket-joint for Lenshood II
- Special designed element to collimate Lenshood II in combination with Duplex when insufficient adjustment range at Duplex
- See **pages 40-41** for information on placing orders

RRP in Euros: 43.00



EXTENSION

- Extension for Lenshood II
- Moves any iris diaphragm further to the rear

5001657 . 30 mm

RRP in Euros: 13.00

5001658 . 50 mm

RRP in Euros: 16.00

VARIANTS FOR DUPLEX PRODUCTS

To fix Duplex, Duplex Insert and Duplex Iris you will need components for the following rearsights

DIOPTR FREE SIGHT



Collimator

Shows optional extras:
Diopter Free Sight,
Duplex, Duplex Insert,
Sight 1,8 Crystal



Lenshood II

LENSHOOD II

19918817

RRP in Euros: **38.00**

COLLIMATOR

19918813

RRP in Euros: **43.00**

COLLIMATOR-SPY



Collimator-Spy

Shows optional extras: Diopter Spy Long,
Duplex, Duplex-Iris, Sight 1,8 Tiny



- Antiglare tube with integrated ball joint for Diopter Spy
as a carrier element for Duplex

19918818

RRP in Euros: **84.00**

ANSCHÜTZ REARSIGHT STEEL REARSIGHT 6702-6802, OBSERVER, SIGHT-BASE, STEYR



Collimator

Shows optional extras: Diopter
Sight-Base, Duplex-Insert,
Sight 1,8 Basic



Lenshood II

LENSHOOD II

19918812

RRP in Euros: **38.00**

COLLIMATOR

19918813

RRP in Euros: **43.00**

DIOPTR STEYR CHALLENGE



Collimator

Lenshood II

LENSHOOD II

19918819

RRP in Euros: **38.00**

COLLIMATOR

19918813

RRP in Euros: **43.00**

DIOPTER PRO 57, TESRO, ANSCHÜTZ 7000

Shows optional extras: Diopter Anschütz 7000, Duplex, Duplex-Iris, Sight 1,8 Startline



LENSHOOD II & ADAPTER 7020

19918816

RRP in Euros: 38.00

COLLIMATOR

19918814

RRP in Euros: 43.00

DIOPTER HÄMMERLI

Shows optional extras: Diopter Hämmerli, Duplex, Duplex-Iris, Sight 1,8 Basic

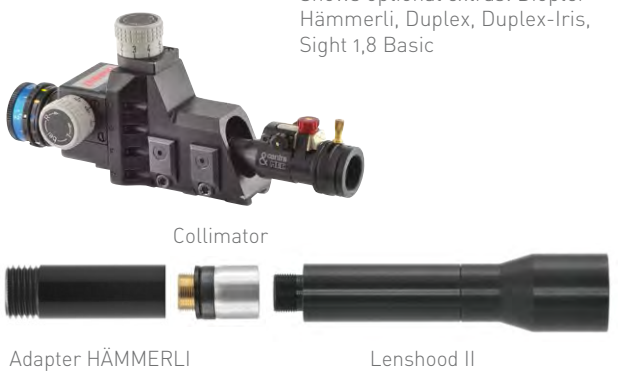

LENSHOOD II & ADAPTER HÄMMERLI

19918815

RRP in Euros: 38.00

COLLIMATOR

19918814

RRP in Euros: 43.00

DIOPTER FEINWERKBAU

Shows optional extras: FWB Diopter, Duplex, Duplex-Iris, Sight 1,8 Basic



LENSHOOD II

19918811

RRP in Euros: 38.00

COLLIMATOR

19918814

RRP in Euros: 43.00

SIGHT 1.8 SUPER AR SIMPLY A NOTCH ABOVE!

The demands on shooters and equipment are getting tougher and tougher. In the World Cup, disciplines such as the air rifle and 60 prone have been switched to decimal scoring. In fact, in supported shooting, more and more shooters are reaching the maximum score. In the end, every decimal point counts!

Of all the various elements in shooting technique, aiming is one of the most elementary and yet also most sensitive aspects of the sport and makes the difference between a good and less than good score.

Our range of **Sight 1.8 Super AR** iris apertures takes sight technology to a whole new level. The iris is our tried-and-tested cutting-edge precision iris with 15 discs. It ensures a perfectly circular aperture across the entire adjustment range.

However, we have achieved a clear improvement in filters. Filter lenses are used to absorb harmful UV light and minimise disruptive light in the visible wavelength spectrum. Because the eye is most responsive to wavelengths around 550 nm, this range is filtered out as little as possible.

All the filters we are using at present are **UV-400 filters** designed to eliminate the UV radiation that is perceived as glare. Another important quality improvement is the **super anti-reflection coating** "AR with clean coat". This treatment improves light transmission significantly by up to 8 percent and prevents troublesome reflections.

The thread connection for the rearsight is made of **steel** and is interchangeable. For example, when using appropriate adapters, the Monocle can be fastened directly to the iris aperture or an additional rearsight optical system can be adapted. **Made for shooters who want the best.**

TRANSMISSION Filter: WL01

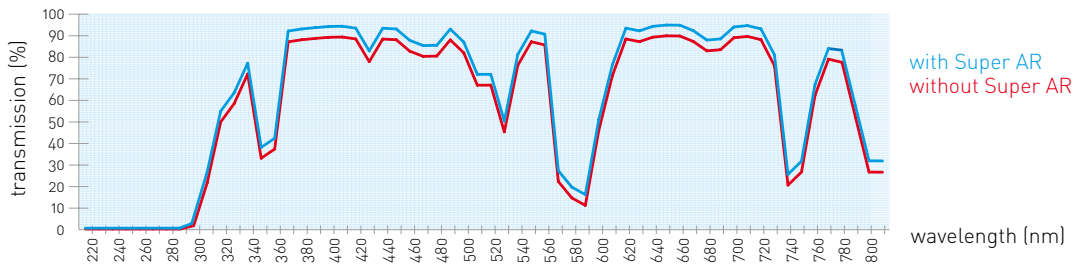

LIGHT SPECTRUM

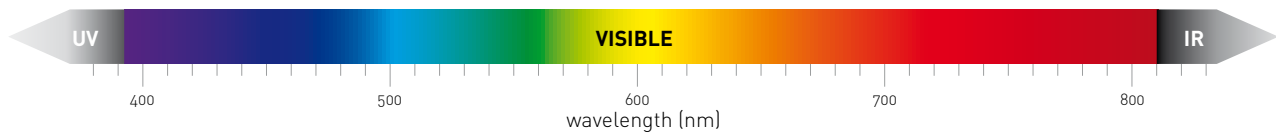

SIGHT 1.8 SUPER AR I



- Iris aperture with integrated 5-colour filter
- Filter colours: ace amethyst, light grey, grey, yellow, peach
- UV-400 filter coating
- Super anti-reflection coating on filter
- Interchangeable steel thread adapter
- Colour: gunmetal / black

19205003

RRP in Euros: **198.00**



SIGHT 1.8 SUPER AR II



- Iris aperture with 10-colour filter and polariser
- Filter colours: ace amethyst, 4 grey levels, yellow, peach, red, green, brown
- UV-400 filter coating
- Super anti-reflection coating on filter
- Interchangeable steel thread adapter
- Colour: gunmetal / black

19205004

RRP in Euros: **279.00**

ADAPTER OK I

- Double thread adapter for use when the optical system on an iris aperture with optical system is to be removed and / or replaced

19906321

RRP in Euros: **17.00**



ADAPTER OK II

- Double thread adapter with thread for direct attachment of the Monocle

19906322

RRP in Euros: **17.00**



ADAPTER OK III

- Double thread adapter for use when fitting the Monocle directly between the iris aperture and the optical system

19906323

RRP in Euros: **17.00**

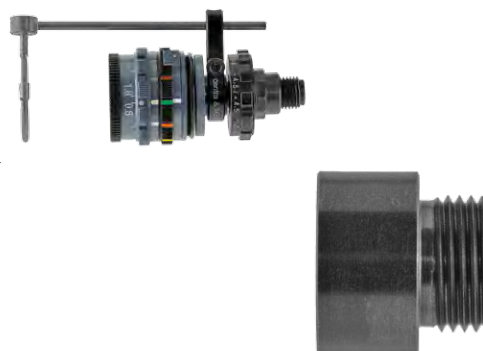

OPTICAL SYSTEM FOR THE IRIS DIAPHRAGMS SUPER AR

- Retrofittable optical system for the iris diaphragms in the Super AR series





19114003

RRP in Euros: **80.00**



SIGHT 1.8 – PROFESSIONAL Basic / Indoor / Twin / Competition

Precision iris with 15 discs, interchangeable sight covers, insertable filter, polished coloured glass filters, individual colour filter variety available upon request. Integrated clamp element for covering the eye. Thread: M 9,5 x 1

-  Adjustment Iris
-  3 colour filter
-  5 colour filter
-  10 colour filter
-  Polarization anti reflection
-  Polarization bright / dark
-  Polarization bright / dark in front sight
-  Optic balance from -4.5 to +4.5 and 1.5 times magnification



SIGHT 1.8 BASIC

- Meeting the demands of an optimal adjustment range from 0.8 – 1.8 mm
- More exact contour of the optical centre
- Basic version
- Colours: silver (Si), black (S), blue (B), red (R)

19200001 + colour

RRP in Euros: 62.00



-  Si
-  S
-  B
-  R

SIGHT 1.8 INDOOR

- Iris aperture with special 5 colour filter for shooting indoors
- Filter colours: Light Gray, Yellow, C41 Peach, C41 Blue, C41 UV
- Colours: silver (Si), black (S), blue (B), red (R)

19201001 + colour

RRP in Euros: 125.00



-  Si
-  S
-  B
-  R

SIGHT 1.8 TWIN



- Iris aperture with a 10 colour filter designed for shooting indoors and out (Indoor-Outdoor combination)
- Filter colours: Light Gray, Gray, Dark Gray, C41 Blue, C41 UV, Yellow, Green, Orange, Brown and C41 Peach
- Colours: silver (Si), black (S), blue (B), red (R)

19201002 + colour

RRP in Euros: 153.00



SIGHT 1.8 COMPETITION



- Iris aperture with a 10 colour filter and an integrated polarization filter
- Filter colours are the same as those of Sight 1,8 Twin
- Colours: silver (Si), black (S), blue (B), red (R)

19202001 + colour

RRP in Euros: 177.00



SIGHT 1.8 PERFORMANCE



- Adjustable rear aperture with five (5) colour filters (C41 Blue, Grey, Yellow, Peach, and Brown) and a polarization filter.
- Front sight tunnel polarization filter insert.
- In combination this system produces optimal sight picture contrast and is infinitely variable for eyes, lighting and range conditions.
- Sight alignment clarity and contrast around the front sight tunnel in the rear sight remains bright and sharp

19203001 + colour	M18
19203002 + colour	M22

RRP in Euros: 182.00



BIATHLONVISIERUNG SIGHT 1.8 BIATHLON



- Iris aperture with a 5 colour filter
- Special coverings for the aiming and the non aiming eye
- Filter colours: Light Gray, Dark Gray, Yellow, Green, C-41 Blue

19211001

RRP in Euros: 179.00



SIGHT 1.8 SENIOR



- Adjustable rear aperture specially made for "Senior Class" competitors
- Large numbers and unique knurled knob design for quick adjustments
- Integrated five (5) filter system in Light Gray, Gray, C41 Blue, Yellow and Peach
- To aid visual acuity a 1.5 magnification can be attached

19204001

RRP in Euros: 160.00



SIGHT 1.8 SENIOR WITH OPTIC



- Adjustable rear aperture specially made for „Senior Class“ competitors
- Large numbers and unique knurled knob design for quick adjustments
- Integrated five (5) filter system in Light Gray, Gray, C41 Blue, Yellow and Peach
- To aid visual acuity a 1.5 magnification can be attached
- Includes 1.5 magnification

19204002

RRP in Euros: 240.00



SIGHT 1.8 TINY



- Micrometre peepsight with a very small frontal profile specially recommended for use with the MEC Free Sight.
- Integrated five (5) filter system (Gray, Dark Gray, C41 Blue, Yellow and Peach)

19205001

RRP in Euros: 160.00



SIGHT 1.8 CRYSTAL



- Iris aperture short, compact and transparent
- Iris aperture with adjustment range 0.8 – 1.8 mm
- Very small and special frontal profile
- Recommended for rearsight Spy and Sight Base 10 – 50

19205002

RRP in Euros: 103.00



SIGHT BASIC STARTLINE



- Standard Iris-disc 0.8 – 1.8 mm
- Large, easy-to-read numbers
- Short design

19204003

RRP in Euros: **49.00**



SIGHT FILTER STARTLINE



- Iris-disc with 3 colour filter
- Filter colours: Yellow, C41 Blue, Gray
- Large, easy-to-read numbers

19204004

RRP in Euros: **95.00**



SIGHT 3.0 – STANDARD Basic / Filter / Pol / Combi

Precision iris with 15 discs, interchangeable sight covers, insertable filter, polished coloured glass filters, individual colour filter variety available upon request. Integrated clamp element for covering the eye. Thread: M 9,5 x 1

-  Adjustment Iris
-  3 colour filter
-  5 colour filter
-  10 colour filter
-  Polarization anti reflection
-  Polarization bright / dark
-  Polarization bright / dark in front sight
-  Optic balance from -4.5 to +4.5 and 1.5 times magnification



SIGHT 3.0 BASIC

- Adjustment range: 0.5 – 3.0 mm
- Even more precise
- Improved handling due to colour & polarization filter control rings
- Standard version
- Colours: silver (Si), black (S), blue (B), red (R)

19110001 + colour

RRP in Euros: 62.00



-  Si
-  S
-  B
-  R

SIGHT 3.0 FILTER

- Iris aperture with special 5 colour filter: Gray, Dark Gray, Yellow, Green, C41 Blue
- Colours: silver (Si), black (S), blue (B), red (R)

19111001 + colour

RRP in Euros: 125.00



-  Si
-  S
-  B
-  R

SIGHT 3.0 POL

- Iris aperture with integrated polarization-filter
- Black eye guard
- Colours: silver (Si), black (S), blue (B), red (R)

19112001 + colour

RRP in Euros: 120.00

**SIGHT 3.0 COMBI**

- Iris aperture with integrated 5 colour and polarizationfilter
- Colours: silver (Si), black (S), blue (B), red (R)

19113001 + colour

RRP in Euros: 153.00

**SIGHT 3.0 BASIC OPTIC**

- Standard version
- Extremely compact optical system that elegantly conforms to the shape of the gun
- Optic balance from -4.5 to +4.5
- 1.5 times magnification
- Colours: silver (Si), black (S), blue (B), red (R)

19114001 + colour

RRP in Euros: 143.00

**SIGHT 3.0 FILTER OPTIC**

- Iris aperture with 5 color filter:
Gray, Dark Gray, Yellow, Green and C41 Blue
- Colours: silver (Si), black (S), blue (B), red (R)

19115001 + colour

RRP in Euros: 199.00



SIGHT 3.0 POL OPTIC



- Iris aperture with integrated polarization-filter
- Extremely compact optical system that elegantly conforms to the shape of the gun
- Optic balance from -4.5 to +4.5
- 1.5 times magnification
- Colours: silver (Si), black (S), blue (B), red (R)

19116001 + colour

RRP in Euros: 189.00



SIGHT 3.0 COMBI OPTIC



- Iris aperture with integrated 5 colour and polarization-filter
- Extremely compact optical system that elegantly conforms to the shape of the gun
- Optic balance from -4.5 to +4.5
- 1.5 times magnification
- Colours: silver (Si), black (S), blue (B), red (R)

19117001 + colour

RRP in Euros: 229.00





IRIS APERTURES ACCESSORIES

MIRROR



- To check your shooting glasses are perfectly positioned
- To check your cheekpiece is perfectly adjusted
- Is your pupil looking directly through the centre of the iris aperture when you're aiming?

MIRROR

19903020

RRP in Euros: **45.00**

MIRROR TINY

- Only for 1.8 Tiny

19903022

RRP in Euros: **33.00**

MIRROR STARTLINE

- Only for Startline filter series

19903021

RRP in Euros: **33.00**

MIRROR STRANGER

- Sight ring with mirror for iris discs from other manufacturers

19903020-gk

RRP in Euros: **55.00**



Prisma with Sight 3.0 Basic on Diopter Spy



PRISMA

- Retrofittable angled eyepiece
- Eyepiece rotating 360°
- Suitable for shooters with handicap

19940039

RRP in Euros: **159.00**

HAWK 4.5

- Retrofittable optical system
- Fits on every centra iris aperture
- Optic balance from -4.5 to +4.5
- 1.5 times magnification

19908020

RRP in Euros: **99.00**



EAGLE

- Adaptor to accommodate your lens
- Rotating 360° to adjust individually
- Accommodates shooting lenses that are 23 mm in diameter
- Fits on original centra iris-discs

19940030

RRP in Euros: **83.00**



EAGLE II

- Adapter for Astigmatism-Lens
- Adapter with integrated Lens to correct astigmatism
- Mount between iris aperture and optic-system
- Can accommodate a shooting lens

	cylinder corr.		cylinder corr.
19940058	-0.25	19940064	-1.75
19940059	-0.50	19940065	-2.00
19940060	-0.75	19940066	-2.25
19940061	-1.00	19940067	-2.50
19940062	-1.25	19940068	-2.75
19940063	-1.50	19940069	-3.00

RRP in Euros: **55.00**

IRIS APERTURES ACCESSORIES

1
2
3
4
5
6
7



INTERCHANGEABLE SIGHT RINGS, TYPE SMALL

- Reacts to the surrounding light
- Insertable colour filters
- For iris apertures with an integrated colour filter
- 5 rings
- Colours: Yellow, Blue, Silver, Green, Red

19903000

RRP in Euros: **25.00**



INTERCHANGEABLE SIGHT RINGS, TYPE BIG

- Reacts to the surrounding light
- Insertable colour filters
- For the basic iris aperture, makes it possible to insert single colour filters
- 6 rings
- Colours: Black, Yellow, Blue, Silver, Green, Red

19903010

RRP in Euros: **29.00**

SYNTHETIC APERTURE RING

- Special plastic aperture ring for all centra iris apertures
- Prevents damage to the lenses of shooting glasses

19903023

RRP in Euros: **20.00**



COLOUR FILTER INSERTS / FILTER SET

- Easy to clean, extendable
- Iris aperture remains extremely short (for those who wear glasses)

19904001	Light Gray	
19904002	Gray	
19904003	Dark Gray	
19904004	Brown	
19904005	Green	
19904006	Yellow	
19904007	Orange	
19904008	C41 Blue	
19904009	C41 UV	
19904010	C41 Peach	
19904000	10 Filter Set	

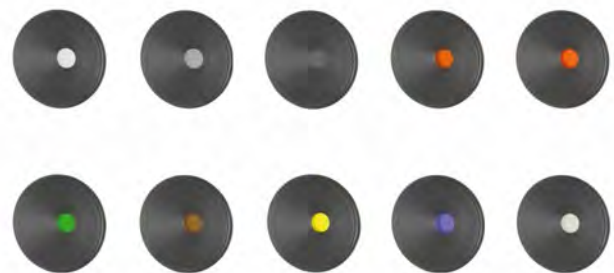

1 Filter: RRP in Euros: **20.00**

10 Filters: RRP in Euros: **175.00**



Shows optional extras:
Spy Short, Sight 1.8 Basic

FLAP

- Non-aiming eye cover
- For Sight 1.8 Tiny and original iris discs "made by centra"
- Can be positioned in precisely the right place

19902009

RRP in Euros: 30.00



Shows optional extras:
Spy Long, Sight 1.8 Basic

FLAP VD

- Non-aiming eye cover
- Like FLAP
- Multiple adjustment options, including variable distance between cover and eye

19902010

RRP in Euros: 40.00



DISC

- Stationary iris disc with a clamp device for eye blinders
- Delivery includes eye blinder
- Fits all current optical sights

19021001

RRP in Euros: 20.00



STRASSER

- Eye-Blinder (rifle shooters)
- Easy to fit
- Colours: beige, transparent

19902007	beige
19902008	transparent

RRP in Euros: 10.00

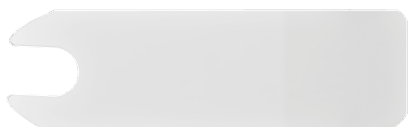

EYE COVER 30 MM

- Easy to fit
- Colours: white, transparent
- Compatible with all iris diaphragms "Made by centra"

19902003	white
19902004	transparent

RRP in Euros: 10.00



ADJUSTABLE FRONT SIGHT RINGS



STANDARD VARIETY



- Excellent value standard variety
- Iris front sight ring beam M18 0.5 mm or M22 0.5 mm
- Colours: silver (Si), black (S), blue (B), red (R)

M18	∅	⊙
19500201 + colour	2.3-4.3	1.6 mm
19500202 + colour	2.8-4.8	1.6 mm
19500203 + colour	2.8-4.8	2.0 mm
19500204 + colour	3.8-5.8	2.0 mm
M22	∅	⊙
19500501 + colour	2.3-4.3	1.6 mm
19500502 + colour	2.8-4.8	1.6 mm
19500503 + colour	2.8-4.8	2.0 mm
19500504 + colour	3.8-5.8	2.0 mm

RRP in Euros: 100.00

VARIO



- Ability to switch the sight from cross hair to cross beam
- Ring width remains the same
- Iris front sight ring beam M18 0.5mm or M22 0.5 mm
- Colours: silver (Si), black (S), blue (B), red (R)

M18	∅	⊙
19502201 + colour	2.3-4.3	1.6 mm
19502202 + colour	2.8-4.8	1.6 mm
19502203 + colour	2.8-4.8	2.0 mm
19502204 + colour	3.8-5.8	2.0 mm
M22	∅	⊙
19502501 + colour	2.3-4.3	1.6 mm
19502502 + colour	2.8-4.8	1.6 mm
19502503 + colour	2.8-4.8	2.0 mm
19502504 + colour	3.8-5.8	2.0 mm
19502506 + colour	5.0-7.0	2.0 mm
19502505 + colour	5.0-7.5	2.0 mm

RRP in Euros: 115.00

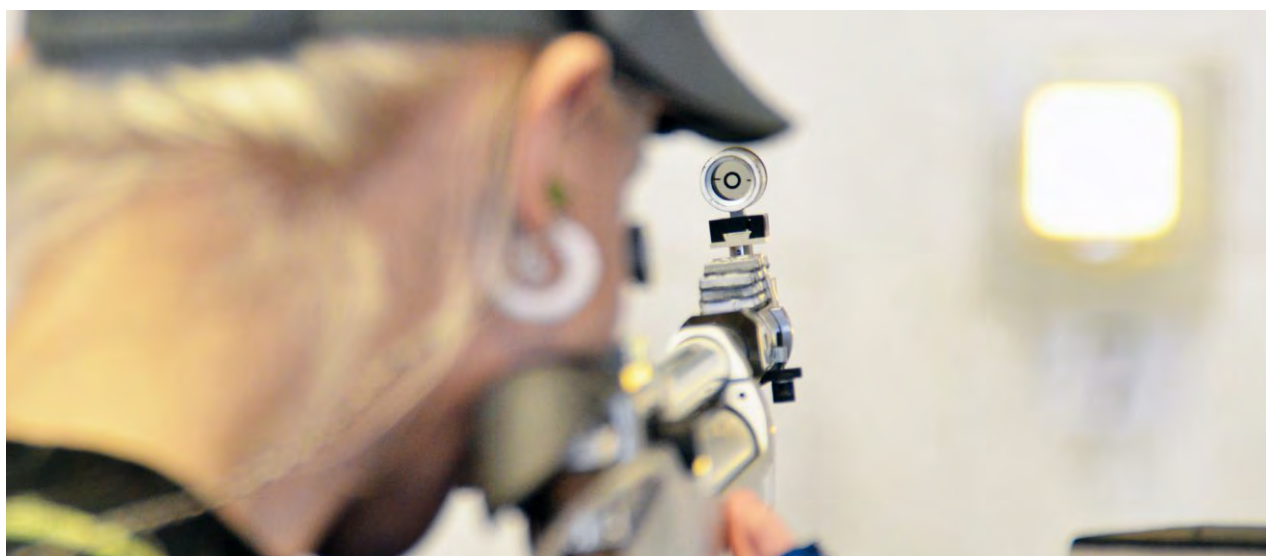



IRIS GLASS FRONT SIGHT



- Polished glass
- Ring width remains the same
- Iris front sight with unmarked iris M18 x 0.5 mm or M22 x 0.5 mm
- Colours: silver (Si), black (S), blue (B), red (R)

M18	M22	∅	⊙
19504229 + colour	19504512 + colour	2.3-3.3	1.2 mm
19504230 + colour	19504513 + colour	2.8-3.8	1.2 mm
19504232 + colour	19504515 + colour	3.4-4.4	1.2 mm
19504231 + colour	19504514 + colour	3.8-4.8	1.2 mm

RRP in Euros: 135.00

M18	M22	∅	⊙
19504200 + colour	19504500 + colour	1.8-4.3	1.6 mm
19504201 + colour	19504501 + colour	2.3-4.3	1.6 mm
19504202 + colour	19504502 + colour	2.8-4.8	1.6 mm

RRP in Euros: 125.00

M18	M22	∅	⊙
19504203 + colour	19504503 + colour	2.8-4.8	2.0 mm
19504204 + colour	19504504 + colour	3.8-5.8	2.0 mm
19504234 + colour	19504535 + colour	5.0-7.0	2.0 mm
	19504530 + colour	6.5-8.5	2.0 mm
	19504531 + colour	8.0-10.0	2.0 mm

RRP in Euros: 125.00



IRIS FILTER GLASS FRONT RING SIGHT



- Polished coloured glass
- Ring width remains the same
- Iris Front Sight with unmarked Iris M18 x 0.5 mm or M22 x 0.5 mm
- Colours: silver (Si), black (S), blue (B), red (R)

M18	M22	∅	⊙
19504238 + colour	19504521 + colour	2.3-3.3	1.2 mm
19504239 + colour	19504522 + colour	2.8-3.8	1.2 mm
19504240 + colour	19504523 + colour	3.8-4.8	1.2 mm
19504241 + colour	19504524 + colour	2.3-3.3	1.2 mm
19504242 + colour	19504525 + colour	2.8-3.8	1.2 mm
19504243 + colour	19504526 + colour	3.8-4.8	1.2 mm
19504244 + colour	19504527 + colour	2.3-3.3	1.2 mm
19504245 + colour	19504528 + colour	2.8-3.8	1.2 mm
19504246 + colour	19504529 + colour	3.8-4.8	1.2 mm

RRP in Euros: 165.00

M18	M22	∅	⊙
19504210 + colour	19504505 + colour	2.8-4.8	1.6 mm
19504212 + colour	19504507 + colour	2.8-4.8	1.6 mm
19504214 + colour	19504509 + colour	2.8-4.8	1.6 mm

RRP in Euros: 155.00

M18	M22	∅	⊙
19504211 + colour	19504506 + colour	3.8-5.8	2.0 mm
19504213 + colour	19504508 + colour	3.8-5.8	2.0 mm
19504215 + colour	19504510 + colour	3.8-5.8	2.0 mm

RRP in Euros: 155.00



VARIO SWING

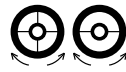

- Ability to change from cross hairs to beam
- Simple setting of canting angles without any tool due to the fact that the axis swivels
- Exact reproduction of different canting angles by scaling
- M18 x 0.5 mm or M22 x 0.5 mm
- Colours: silver (Si), black (S), blue (B), red (R)

M18	M22	∅	⊙
19602201 + colour	19603501 + colour	2.3-4.3	1.6 mm
19602202 + colour	19603502 + colour	2.8-4.8	1.6 mm
M18	M22	∅	⊙
19602204 + colour	19603504 + colour	2.8-4.8	2.0 mm
19602206 + colour	19603506 + colour	3.8-5.8	2.0 mm
	19603508 + colour	5.0-7.5	2.0 mm

RRP in Euros: **125.00**

VARIO SQUARE



- Adjustable front-sighting with square outline
- Simple setting of canting angles without any tool due to the fact that the axis swivels
- Colours: silver (Si), black (S), blue (B), red (R)

M18	M22	∅
19603517 + colour	19603514 + colour	2.8-4.8
19603511 + colour	19603513 + colour	3.8-5.8
	19603510 + colour	5.0-7.5

RRP in Euros: **145.00**



SQUARE GLAS



- Adjustable front-sighting with square outline
- Polished glass
- Colours: silver (Si), black (S), blue (B), red (R)

M18	M22	∅
19504205 + colour	19504207 + colour	2.8-4.8
19504206 + colour	19504208 + colour	3.8-5.8
	19504532 + colour	6.5-8.5
	19504533 + colour	8.0-10.0

RRP in Euros: **154.00**

DUO FRONT RING SIGHTS

Separate adjustments of the inside and outside diameter resulting in variable ring widths, simple setting of canting angles by means of the swiveling tunnel, scaling makes it easier to reproduce canting angles



DUO-VARIO

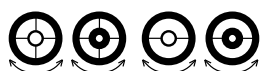

- Ability to switch the sight from cross hairs to cross beam
- Colours: silver (Si), black (S), blue (B), red (R)

M18	M22	ANSCHÜTZ
19702002 + colour	19712002 + colour	2.8-4.8 in / 6.4-9.0 out
19702005 + colour	19712005 + colour	3.8-5.8 in / 7.6-10.2 out
M18	M22	FEINWERKBAU
19702008 + colour	19712008 + colour	2.8-4.8 in / 6.4-9.0 out
19702011 + colour	19712011 + colour	3.8-5.8 in / 7.6-10.2 out
M18	M22	WALTHER
19702014 + colour	19712014 + colour	2.8-4.8 in / 6.4-9.0 out
19702017 + colour	19712017 + colour	3.8-5.8 in / 7.6-10.2 out

RRP in Euros: 189.00

DUO-GLASS



- Polished glass
- Insertable cross pin for canting control
- Colours: silver (Si), black (S), blue (B), red (R)

M18	M22	ANSCHÜTZ
19704002 + colour	19714002 + colour	2.8-4.8 in / 6.4-9.0 out
19704005 + colour	19714005 + colour	3.8-5.8 in / 7.6-10.2 out
M18	M22	FEINWERKBAU
19704008 + colour	19714008 + colour	2.8-4.8 in / 6.4-9.0 out
19704011 + colour	19714011 + colour	3.8-5.8 in / 7.6-10.2 out
M18	M22	WALTHER
19704014 + colour	19714014 + colour	2.8-4.8 in / 6.4-9.0 out
19704017 + colour	19714017 + colour	3.8-5.8 in / 7.6-10.2 out

RRP in Euros: 189.00



UNMARKED FRONT SIGHT RINGS

HIGH END CIRCLE



- Polished glass
- Refractive free front sight insert
- Suitable for large calibre
- Different ring widths

Available sizes: M18 and M22

Diameter 3.0 – 7.5 in 0.1 mm steps

Ring widths 1.0 – 1.4 in 0.1 mm steps

Only M22!!: Diameter 7.6 – 10.0 in 0.1 mm steps



Clear glass: order example below

RRP in Euros: 21.00

Coloured glass: order example below

RRP in Euros: 31.50

HIGH END 2,6



Available sizes: M18: 4.5-7.5 and M22: 4.5-10.0

Ring width 2.6 mm

Available only with clear glass



RRP in Euros: 22.00

Order example below

Order example for High End Circle, 2.6 & Crystal

Thread	Diameter	Ring width	
M18 = 2	3.4 = 34	1.0 = 10	+ Colour C = Clear Y = Yellow R = Red B = Blue
M22 = 5	4.2 = 42	1.4 = 14	

1	9	4	2	3	4	1	4	C
---	---	---	---	---	---	---	---	---

For Crystal please write "Crystal"!



Clear glass: order example on the left

RRP in Euros: 23.00

Coloured glass: order example on the left

RRP in Euros: 35.50

HIGH END CRYSTAL



- Suitable for Score Crystal

HIGH END SQUARE



Front sight developed for benchrest shooting

- Polished glass with metal square insert
- M18 and M22 available from 3.0 mm – 7.5 mm
- M22 also available in 7.6 mm – 10.0 mm



Thread	Dia- meter
M18 = 6	3.4 = 34
M22 = 7	4.2 = 42

1	9	4	6	3	4	1	6
---	---	---	---	---	---	---	---

Order example above right

RRP in Euros: 22.50

FRONT SIGHT VERTICAL

- Front sight insert, able to rotate on its own axle without any tool
- Different widths

M18	M22	ring width
19320024	19350024	2.4 mm
19320026	19350026	2.6 mm
19320028	19350028	2.8 mm
19320030	19350030	3.0 mm



RRP in Euros: 30.00

THESE NEW PRODUCTS

can be found on **pages 9-10**.



Score Accuracy



Score Accuracy Plus



Red M22-M18



Mag M18-M22



Score Composite

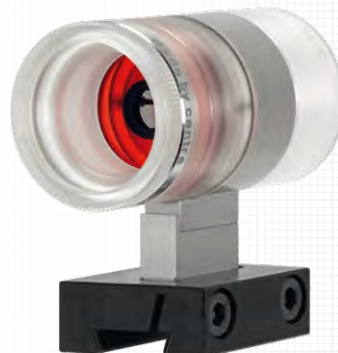

Score Composite Plus



Shows optional extra High End

SCORE



- Steplessly variable, swivels on the axle without any tool
- Insertable cross pin for tilt control
- Exact reproduction of different canting angles by scaling
- Small vertical reference bar
- Available in M18 and M22

M18	M22	
19906001 + colour	19906201 + colour	ANSCHÜTZ
19906002 + colour	19906202 + colour	FEINWERKBAU
19906003 + colour	19906203 + colour	WALTHER
19906004 + colour	19906204 + colour	STEYR
19906005 + colour	19906205 + colour	HÄMMERLI
19906006 + colour	19906206 + colour	MATCH 54
19906007 + colour	19906207 + colour	SUHLER

RRP in Euros: **73.00**



Shows optional extra High End

SCORE PLUS



- Like Score, plus integrated sight elevation of 8 mm

Tunnel

RRP in Euros: **80.00**

With rearsight elevation

RRP in Euros: **112.00**

Tunnel	With rearsight elevation	M18
19906011 + colour	19913201 + colour	ANSCHÜTZ
19906012 + colour	19913202 + colour	FEINWERKBAU
19906013 + colour	19913203 + colour	WALTHER
19906014 + colour	19913204 + colour	STEYR
19906015 + colour	19913205 + colour	HÄMMERLI
19906022 + colour	19913212 + colour	MATCH 54
19906023 + colour	19913213 + colour	SUHLER

Tunnel	With rearsight elevation	M22
19906211 + colour	19913501 + colour	ANSCHÜTZ
19906212 + colour	19913502 + colour	FEINWERKBAU
19906213 + colour	19913503 + colour	WALTHER
19906214 + colour	19913504 + colour	STEYR
19906215 + colour	19913505 + colour	HÄMMERLI
19906216 + colour	19913506 + colour	MATCH 54
19906217 + colour	19913507 + colour	SUHLER





SCORE HR

- Vertical adjustment range in 1 mm steps
- Elevation from 12 mm up to 26 mm
- Realize a special slim sight picture
- Compatible with rear-sight elevation block-max and block-club
- Available in M18 and M22

Tunnel	With rearsight elevation	M18
19906016 + colour	19913206 + colour	ANSCHÜTZ
19906017 + colour	19913207 + colour	FEINWERKBAU
19906018 + colour	19913208 + colour	WALTHER
19906019 + colour	19913209 + colour	STEYR
19906020 + colour	19913210 + colour	HÄMMERLI
19906021 + colour	19913211 + colour	MATCH 54

Tunnel	With rearsight elevation	M22
19906228 + colour	19913516 + colour	ANSCHÜTZ
19906229 + colour	19913517 + colour	FEINWERKBAU
19906230 + colour	19913518 + colour	WALTHER
19906231 + colour	19913519 + colour	STEYR
19906232 + colour	19913520 + colour	HÄMMERLI
19906233 + colour	19913521 + colour	MATCH 54

Tunnel
RRP in Euros: 103.00
 With rearsight elevation
RRP in Euros: 177.00



SCORE SPEED

- Front-sight tunnel, designed for the new ISSF final-rules
- Scamping element from steel
 - Quick installation without tool by special screws
 - Applicable cross pins for tilt control

- Exact reproduction of different canting angles by scaling
- Small vertical reference bar
- Available in M18 and M22

M18	M22	
19906234 + colour	19906240 + colour	ANSCHÜTZ
19906235 + colour	19906241 + colour	FEINWERKBAU
19906236 + colour	19906242 + colour	WALTHER
19906237 + colour	19906243 + colour	STEYR
19906238 + colour	19906244 + colour	BLEIKER
19906239 + colour	19906245 + colour	MATCH 54

RRP in Euros: 89.00



SCORE CRYSTAL

- Transparent housing for maximum brightness
- Infinitely variable, swivels on the axel
 - Insertable cross pins for tilt control
 - Available in M18 and M22

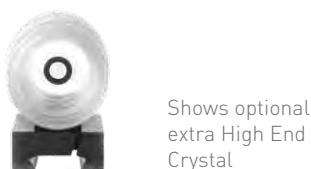

M18	M22	
19913506	19913511	ANSCHÜTZ
19913507	19913512	FEINWERKBAU
19913508	19913513	WALTHER
19913509	19913514	STEYR
19913510	19913515	HÄMMERLI
19913522	19913523	MATCH 54

RRP in Euros: 77.00



DOVETAIL SCORE SPEED

– Dovetail for exchange for centra Score front sight-tunnels

199014707	ANSCHÜTZ
199014708	FEINWERKBAU
199014709	WALTHER
199014710	STEYR
199014711	BLEIKER
199014712	MATCH 54

RRP in Euros: **42.00**

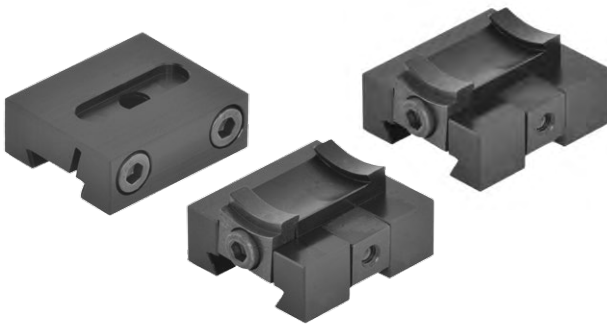

CHANGEABLE SIGHT DOVETAILS

- For Front Sight Tunnel Score and Score Crystal
- For Duo-Front-Sight-Rings
- As well as for other custom made articles

DUO M18	DUO M22	Score	
199014201	199014501	199014701	ANSCHÜTZ
199014202	199014502	199014702	FEINWERKBAU
199014203	199014503	199014703	WALTHER
199014204	199014504	199014704	STEYR
199014205	199014505	199014705	HÄMMERLI

RRP in Euros: **30.00**



Shows Rotary with the Duo-Glass Front Ring Sight

ROTARY

- Synthetic dust covers (pair)
- Supple, soft covers
- Protect from dust, dirt and damage
- M22 fits Iris aperture

19R00001	M18
19R00002	M22

RRP in Euros: **5.00**



ANTIGLARE-TUBE

- Antiglaretube for front-sight-tunnel
- Additional female thread for mounting coloured lenses, glasses, spirit-bubbler, eagle eyes

19906301	M18
19906302	M22

RRP in Euros: 29.00

THESE NEW PRODUCTS

can be found on **page 10**.



Adapter AT



Ring AT



OUR NEW PRODUCT

can be found on **page 11**.

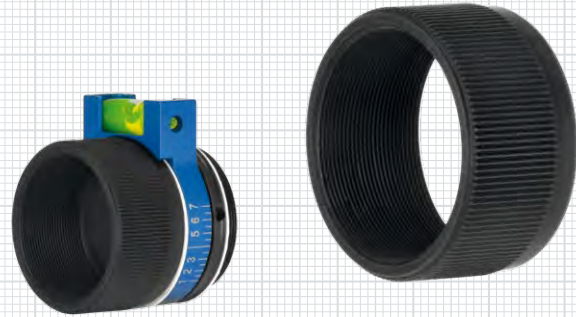

Adapter Level

NEW



- Si
- S
- B
- R

LEVEL

- Adjustment without tools
- Exact reproduction of different canting angles by scaling
- Two sizes: M18 and M22

19907001 + colour	M18
19907201 + colour	M22

RRP in Euros: 59.00



Shows optional extra
Score Crystal and
High End Crystal



LEVEL CRYSTAL

- Spiritbubble, transparent, perfect perception
- Adjustment without tools
- Exact reproduction of different canting angles by scaling
- Two sizes: M18 and M22

19907003	M18
19907203	M22

RRP in Euros: 66.00



Shows Lib Light on
Front Sight Ring Duo Glas



LIB-LIGHT

- Illuminator for bubble levels
- With adjustable brightness
- Includes on/off switch
- Two sizes: M18 and M22

19907302	M18
19907305	M22

RRP in Euros: 66.00

- Si
- S
- B
- R



LEVEL 2

Internal mounted spirit level

- Adjustment without tools
- Exact reproduction of different canting angles by scaling
- Integrated antiglare tube
- Two sizes: M18 and M22

19907301 + colour	M18
19907401 + colour	M22

RRP in Euros: 69.00



ARTHOR

Artificial horizon to check canting

- Adjustable without a tool
- For fix front-sights (Score, High End, Polarizer, Filter FS)

19940020	M18
19940022	M22

RRP in Euros: 55.00



Shows optional extra Duo Vario



PEAK

- For more precision during pre-aiming
- Adjustable without a tool
- Simple aid to improve your results
- For M18 only

19940028

RRP in Euros: 51.00





POLARIZER SINGLE

- Polarization filter insert for the front sight tunnel
- Combines with polarization in the rear sight to eliminate glare and optimize the contrast of the sight picture reference area.

19940024	M18
19940025	M22

RRP in Euros: **26.00**



POLARIZER DOUBLE

- Two (2) polarization filter inserts for the front sight globe
- Manipulating the two filters adjusts the sight picture for optimum contrast
- Sight alignment reference area around the rear sight globe in the rear aperture remains clear

19940026	M18
19940027	M22

RRP in Euros: **50.00**



FILTER FS

Color filter glass for front-sight-tunnel

- With female thread for spirit level or eagle eye
- For a better sight picture contrast
- Fit for all current front-sight-tunnels and Duos

	Ø	M18
19940031	front sights 3.0-4.8	Yellow
19940033	front sights 4.9-7.0	Yellow
19940035	front sights 3.0-4.8	Red
19940037	front sights 4.9-7.0	Red
19940052	front sights 3.0-4.8	Blue
19940054	front sights 4.9-7.0	Blue
	Ø	M22
19940032	front sights 3.0-4.8	Yellow
19940034	front sights 4.9-7.0	Yellow
19940078	front sights 6.5-10.0	Yellow
19940036	front sights 3.0-4.8	Red
19940038	front sights 4.9-7.0	Red
19940079	front sights 6.5-10.0	Red
19940053	front sights 3.0-4.8	Blue
19940055	front sights 4.9-7.0	Blue
19940080	front sights 6.5-10.0	Blue

RRP in Euros: **31.50**



MEC EAGLE-EYE CHANGE

- High-quality coating of the lenses BaK-4
- Multiple times AR coated
- Special holders allow an easy exchange of the lenses
- 0.3 diopters
- Available in M18 and M22

M18	M22	
5009937	5009938	Set 0.3, 0.5, 0.75

RRP in Euros: **105.00**

5009927	5009928	Adapter
---------	---------	---------

RRP in Euros: **30.00**

5009929	5009933	0.3 diopters
5009930	5009934	0.5 diopters
5009931	5009935	0.6 diopters
5009932	5009936	0.75 diopters

RRP in Euros: **25.00**



EAGLE EYE

- Visual, multilayer-coated special lens
- With female thread for Spirit Bubble
- Available in M18 and M22

M18	M22	diopters
19915203	19915503	0.3
19915205	19915505	0.5
19915207	19915527	0.75

RRP in Euros: **38.00**

M18	M22	diopters
19915528	19915529	0.6

RRP in Euros: **41.00**



EAGLE EYE CRYSTAL

- For Score Crystal
- With female thread for Spirit Bubble
- Available in M18 and M22

M18	M22	diopters
19915209	19915501	0.3
19915208	19915502	0.5
19915210	19915500	0.75

RRP in Euros: **44.00**

M18	M22	diopters
19915530	19915531	0.6

RRP in Euros: **46.50**



FRONT SIGHT OPTIC VARIO

- Adjustable Eagle Eye, adjustment range 0.1 to 0.5 diopters, stepless

19915506	M18
19915507	M22

RRP in Euros: **115.00**



FRONT SIGHT OPTIC VARIO-INTEGRAL

- Integrated adjustable Eagle Eye
- Short Construction
- Combination with adjustable front sight rings possible (shorter than 50 mm at AR)

M18	M22	
19915508	19915509	ANSCHÜTZ
19915523	19915524	FEINWERKBAU
19915525	19915526	WALTHER

RRP in Euros: **166.00**

1

2

3

4

5

6

7

SIGHT ELEVATION



BLOCK 4

- Suitable for all current competition guns
- Elevation of 4 mm

Complete	Rearsight elevation	Tunnel elev.	
19912101	19910101	Block 4/A/K	ANSCHÜTZ
19912102	19910102	Block 4/F/K	FEINWERKBAU
19912103	19910103	Block 4/W/K	WALTHER
19912104	19910104	Block 4/S/K	STEYR
19912105	19910105	Block 4/H/K	HÄMMERLI

Complete

RRP in Euros: 40.00

Rearsight elevation

RRP in Euros: 23.00

Tunnel elevation

RRP in Euros: 18.00



BLOCK 8

- Suitable for all current competition guns
- Elevation of 8 mm

Complete	Rearsight elevation	Tunnel elev.	
19912201	19910201	19910201/K	ANSCHÜTZ
19912202	19910202	19910202/K	FEINWERKBAU
19912203	19910203	19910203/K	WALTHER
19912204	19910204	19910204/K	STEYR
19912205	19910205	19910205/K	BLEIKER

Complete

RRP in Euros: 60.00

Rearsight elevation

RRP in Euros: 33.00

Tunnel elevation

RRP in Euros: 29.00

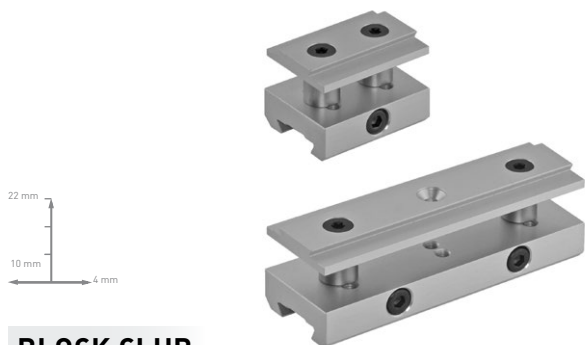

BLOCK CLUB

- Vertical and horizontal adjustment of the sightline
- Base height of 10 mm
- Vertical adjustment in 4 mm increments up to final height of 22 mm
- One maximum horizontal offset out to 4 mm
- Rear-sight-dovetail can shift 25 mm

19915901	ANSCHÜTZ
19915900	MATCH 54
19915902	FEINWERKBAU
19915903	WALTHER
19915904	STEYR
19915905	BLEIKER

RRP in Euros: 83.00



BLOCK MAX

- Vertical adjustment of the sightline, base height 18 mm
- Vertical adjustment ranges from 18 mm to 27 mm in increments of 1 mm

Complete	Rearsight elevation	Tunnel elev.	
19913902	19913907	19913912	ANSCHÜTZ
19913903	19913908	19913913	FEINWERKBAU
19913904	19913909	19913914	WALTHER
19913905	19913910	19913915	STEYR
19913906	19913911	19913916	BLEIKER

Complete

RRP in Euros: 129.00

Rearsight elevation

RRP in Euros: 73.00

Tunnel elevation

RRP in Euros: 63.00



TRACK

- Infinitely variable side adjustment
- Elevation of 9 mm
- Suitable for all current competition guns

Complete	Rearsight elevation	Tunnel elev.	
19912901	19912901/D	19912901/K	ANSCHÜTZ
19912900	19912900/D	19912900/K	MATCH 54
19912902	19912902/D	19912902/K	FEINWERKBAU
19912903	19912903/D	19912903/K	WALTHER
19912904	19912904/D	19912904/K	STEYR
19912905	19912905/D	19912905/K	BLEIKER

Complete

RRP in Euros: 99.00

Rearsight elevation

RRP in Euros: 64.00

Tunnel elevation

RRP in Euros: 54.00



TRACK MAX

- Vertical and horizontal adjustment of the sightline
- Infinite increments of horizontal offset out to a maximum of 8 mm
- Vertical adjustment from a base of 22 mm to a final height of 27 mm in 1 mm increments

Complete	Rearsight elevation	Tunnel elev.	
19914900			MATCH 54
19914901	19914906	19914911	ANSCHÜTZ
19914902	19914907	19914912	FEINWERKBAU
19914903	19914908	19914913	WALTHER
19914904	19914909	19914914	STEYR
19914905	19914910	19914915	BLEIKER

Complete

RRP in Euros: 179.00

Rearsight elevation

RRP in Euros: 108.00

Tunnel elevation

RRP in Euros: 93.00

RAISER

Universal sight elevation of 8 mm

- Variable width
- Fits for ANSCHÜTZ, FWB and WALTHER

19940040

RRP in Euros: 66.00



OUR NEW PRODUCT

Block 6 can be found on **page 11**.



NEW



BLOCK 8 SPEED

- Raiser block quick installation kit
- Installation without tools
- Suitable for all current competition guns
- Elevation of 8 mm

Complete	Rearsight elevation	
19917941	19917946	ANSCHÜTZ
19917942	19917947	FEINWERKBAU
19917943	19917948	WALTHER
19917944	19917949	BLEIKER
19917945	19917950	STEYR
19917975	19917976	MATCH 54

Complete

RRP in Euros: 94.00

Rearsight elevation

RRP in Euros: 52.00



BLOCK CLUB SPEED

- Installation without tool
- Base height of 10 mm
- Vertical adjustment in 4 mm increments up to final height of 22 mm
- One maximum horizontal offset out to 4 mm
- Rear-sight-dovetail can shift 25 mm

19917951	ANSCHÜTZ
19917952	FEINWERKBAU
19917953	WALTHER
19917954	BLEIKER
19917955	STEYR
19917981	MATCH 54

RRP in Euros: 120.00



BLOCK MAX SPEED

- Raiser block quick installation kit
- Installation without tools
- Base height of 18 mm
- Vertical adjustment ranges from 18 mm to 27 mm in increments of 1 mm

19917956	ANSCHÜTZ
19917957	FEINWERKBAU
19917958	WALTHER
19917959	BLEIKER
19917960	STEYR
19917973	MATCH 54

RRP in Euros: 163.00



SPEED-KIT BLOCK X

- Screw and clamping set for raiser blocks
- Quick installation without tools by special screws
 - Fits: Block 8, Block-Club, Block-Max, Tele-Flight

Scope of delivery:

3 screws, 1 nut, 1 clamp

19917939

RRP in Euros: 39.00



TRACK SPEED

Raiser block quick installation kit

- Installation without tools
- Infinitely variable side adjustment
- Elevation of 9 mm
- Suitable for all current competition guns

19917961	ANSCHÜTZ
19917962	FEINWERKBAU
19917963	WALTHER
19917964	BLEIKER
19917965	STEYR
19917982	MATCH 54

RRP in Euros: **124.00**

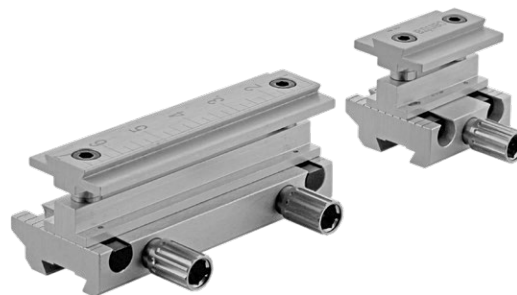

TRACK MAX SPEED

Raiser block quick installation kit

- Installation without tools
- Infinite increments of horizontal offset out to a maximum of 8 mm
- Vertical adjustment from a base of 22 mm to a final height of 27 mm in 1 mm increments

19917966	ANSCHÜTZ
19917967	FEINWERKBAU
19917968	WALTHER
19917969	BLEIKER
19917970	STEYR
19917971	MATCH 54

RRP in Euros: **217.00**

SPEED-KIT TRACK X

Screw and clamping set for raiser blocks

- Fits Track, Track-Max
- Scope of delivery: 3 screws



19917940

RRP in Euros: **30.00**



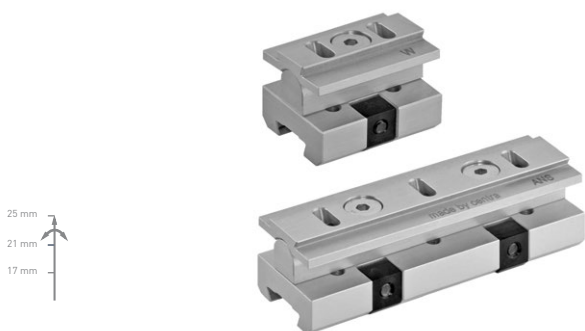

BLOCK SWING

- Vertical pointing, height- and side adjustable sight risers
- Base height 17 mm
- Vertical adjustment in 4 mm increments up to final height of 25 mm with additional available accessories
- Sight line can be vertically shifted up to 4 mm

Complete	Rearsight elevation	Tunnel elev.	
19916901	19916901D	19916901K	ANSCHÜTZ
19916900	19916900D	19916900K	MATCH 54
19916902	19916902D	19916902K	FEINWERKBAU
19916903	19916903D	19916903K	WALTHER
19916904	19916904D	19916904K	STEYR
19916906	19916906D	19916906K	HÄMMERLI
19916907	19916907D	19916907K	BLEIKER

Complete
RRP in Euros: **129.00**

Rearsight elevation
RRP in Euros: **68.00**

Tunnel elevation
RRP in Euros: **68.00**

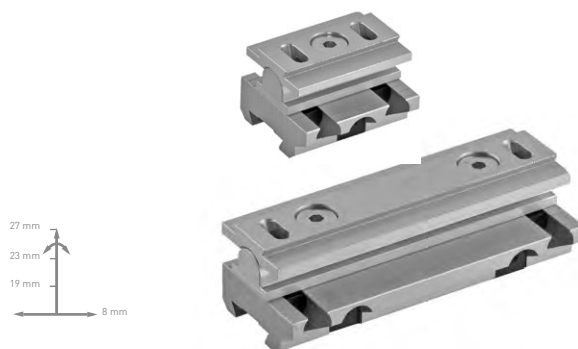

TRACK SWING

- Vertical pointing, height- and side adjustable sight risers
- Base height 19 mm
- Vertical adjustment in 4 mm increments up to final height of 27 mm with additional available accessories
- Sight line can be vertically shifted up to 8 mm

Complete	Rearsight elevation	Tunnel elev.	
19917901	19917901D	19917901K	ANSCHÜTZ
19917900	19917900D	19917900K	MATCH 54
19917902	19917902D	19917902K	FEINWERKBAU
19917903	19917903D	19917903K	WALTHER
19917904	19917904D	19917904K	STEYR
19917905	19917905D	19917905K	HÄMMERLI
19917906	19917906D	19917906K	BLEIKER

Complete
RRP in Euros: **189.00**

Rearsight elevation
RRP in Euros: **95.00**

Tunnel elevation
RRP in Euros: **95.00**



BLOCK SWING-SET UP

– For the rising to 21 mm or 25 mm

19916908	4 mm
19916909	8 mm

RRP in Euros: **45.00**



TRACK SWING-SET UP

– For the rising to 23 mm or 27 mm

19917907	4 mm
19917908	8 mm

RRP in Euros: **54.00**



BLOCK CLUB UPGRADE

– To upgrade from Block Club to Block Swing

BASIC (17 mm)

19916918	ANSCHÜTZ
19916919	FEINWERKBAU
19916920	WALTHER
19916921	STEYR
19916922	HÄMMERLI
19916933	BLEIKER
19916934	MATCH 54

+ 4 mm (21 mm)

19916923	ANSCHÜTZ
19916924	FEINWERKBAU
19916925	WALTHER
19916926	STEYR
19916927	HÄMMERLI
19916935	BLEIKER
19916936	MATCH 54

+ 8 mm (25 mm)

19916928	ANSCHÜTZ
19916929	FEINWERKBAU
19916930	WALTHER
19916931	STEYR
19916932	HÄMMERLI
19916937	BLEIKER
19916938	MATCH 54

RRP in Euros: **79.00**



TRACK UPGRADE

– To upgrade from Track to Track Swing

BASIC (19 mm)

19917918	ANSCHÜTZ
19917919	FEINWERKBAU
19917920	WALTHER
19917921	STEYR
19917922	HÄMMERLI
19917933	BLEIKER
19917934	ANS. MATCH 54

+ 4 mm (23 mm)

19917923	ANSCHÜTZ
19917924	FEINWERKBAU
19917925	WALTHER
19917926	STEYR
19917927	HÄMMERLI
19917935	BLEIKER
19917936	MATCH 54

+ 8 mm (27 mm)

19917928	ANSCHÜTZ
19917929	FEINWERKBAU
19917930	WALTHER
19917931	STEYR
19917932	HÄMMERLI
19917937	BLEIKER
19917938	MATCH 54

RRP in Euros: **94.00**



BLOCK SWING-FLIGHT

– Accessory to allow a further extension of your front sight

19916913	ANSCHÜTZ
19916914	FEINWERKBAU
19916915	WALTHER
19916916	STEYR
19916917	HÄMMERLI

RRP in Euros: **39.00**



TRACK SWING-FLIGHT

– Accessory to allow a further extension of your front-sight

19917913	ANSCHÜTZ
19917914	FEINWERKBAU
19917915	WALTHER
19917916	STEYR
19917917	HÄMMERLI

RRP in Euros: **50.00**

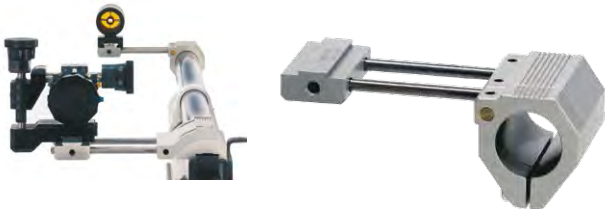

EYE II CLAMP

- Individual adjustment for your eye distance
- Swivelling around axis of barrel
- Locating-ring for easy montage and demontage
- Weight: 245 g



Air-Rifle	Small Bore .22	
19908010	19908110 +*	ANSCHÜTZ
19908011	19908111 +*	FEINWERKBAU
19908012	19908112 +*	WALTHER

*Diameter of barrel

RRP in Euros: **269.00**



EYE II RAIL

– Rearsight can be mounted on original dovetail of your rifle

19908013	ANSCHÜTZ
19908014	FEINWERKBAU
19908015	WALTHER

RRP in Euros: **262.00**



EYE II RAIL PRO

- Variable sight-shift with micro-adjustment of front sight-shift
- Facilitates simple and precise set up of front sightshift

Complete	Front sight-shift	
19908021	19908024	ANSCHÜTZ
19908022	19908025	FEINWERKBAU
19908023	19908026	WALTHER

Complete

RRP in Euros: **309.00**

Separate front sight-shift

RRP in Euros: **166.00**

MEC SWAP

Redirecting the sight picture with an offset of 65 mm to the better eye

- The sight picture is unaltered: bright, brilliant, undistorted
- Distance between eye and rearsight can be varied between 40 and 70 mm
- Design allows the observation of wind flags
- Attachment requires no additional parts
- Sight line can be continuously pivoted 360°
- Separately available coupling element
- Connection M9,5 x 1 for all common rearsight and irises

5000117

RRP in Euros: 299.00



MEC SWAP COMFORT

More flexibility of the sight picture

- The sight picture is unaltered: bright, brilliant, undistorted
- Offers special comfort for benchrest shooting
- Ensures a comfortable head position
- Design allows the observation of wind flags
- Attachment requires no additional parts
- Sight line can be continuously pivoted 360°
- Can be used on several rifles due to the separately available coupling element
- Connection M9,5 x 1 for all common rearsight and irises

5000127

RRP in Euros: 295.00



SWAP COUPLING ELEMENT

- For coupling MEC SWAP and MEC SWAP COMFORT to several different types of rifle

5028234

RRP in Euros: 115.00

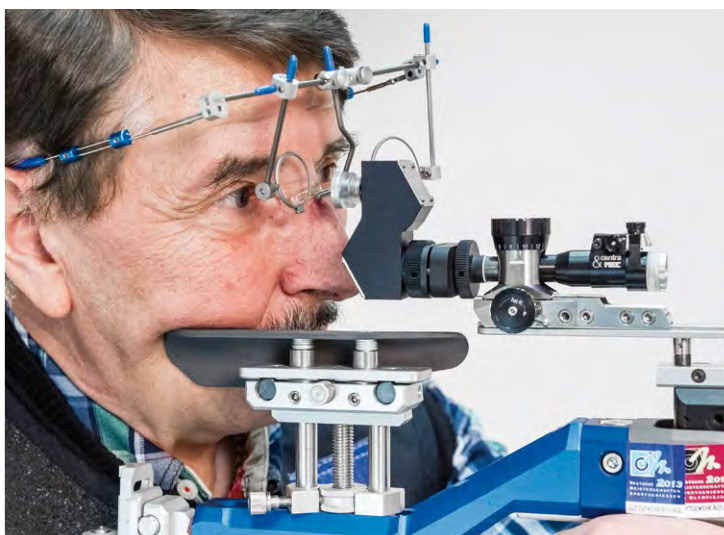

TELE

- Stepped block, brings the rear sight rearwards to the shoulder

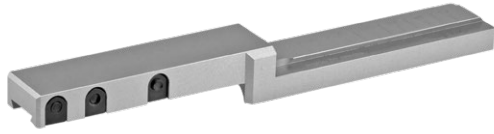

19908001	ANSCHÜTZ
	WALTHER
	STEYR
19908002	HÄMMERLI
	FEINWERKBAU

RRP in Euros: **94.00**

TELE HR

- Stepped block, brings the rear sight rearwards to the shoulder. Multifunctional, dovetails on both sides
- Integrated sight elevation 16 mm
- To combine with front-sight-elevation Block 16k

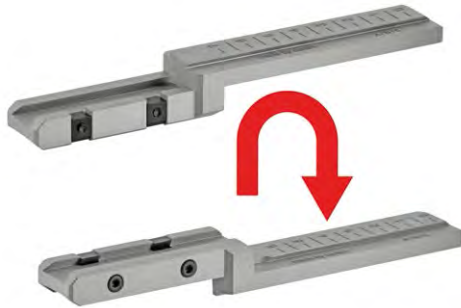

1990821	ANSCHÜTZ
	WALTHER
	STEYR
1990822	HÄMMERLI
	FEINWERKBAU

RRP in Euros: **115.00**

BLOCK 16 K

- To combine with Tele HR



19915916	ANSCHÜTZ
19915917	FEINWERKBAU
19915918	WALTHER
19915919	STEYR
19915920	HÄMMERLI

RRP in Euros: **41.00**

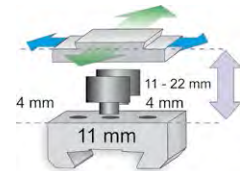

TELE FLIGHT

Multifunctional elevation

- Height and side adjustable
- Max height: 22 mm
- Min height: 11 mm
- Possible side adjustment 4 mm to the left and right
- Possibility to mount a scope

Complete	Rearsight elevation	
1990826	1990832	ANSCHÜTZ
1990827	1990833	FEINWERKBAU
1990828	1990834	WALTHER
1990831	1990836	STEYR
1990830	1990835	HÄMMERLI
1990842		MATCH 54

Complete

RRP in Euros: **120.00**

Rearsight elevation

RRP in Euros: **80.00**

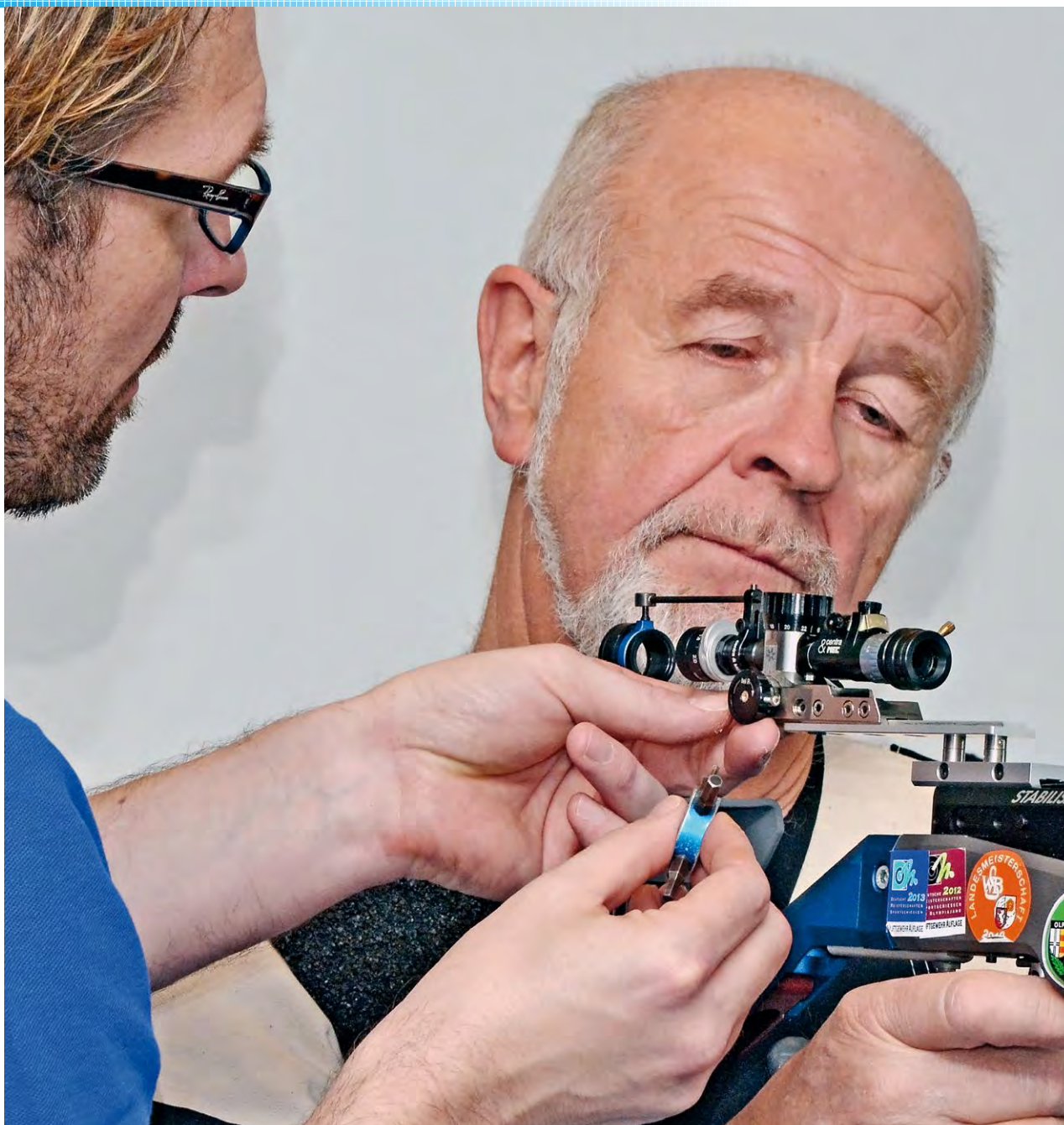

REAR SIGHT RAIL

- For retrofitting
- Can be used to convert Block Club into Tele Flight
- Option of mounting a telescope
- Minimum elevation: 11 mm
- Length of rearsight rail: 116 mm
- Rearsight rail only!

1990837

ANSCHÜTZ

1990838

FEINWERKBAU

1990839

WALTHER

1990840

HÄMMERLI

1990841

STEYR

RRP in Euros: **41.00**

FLIP-UP SPORT

Precision-Flip-Up sight for sport-shooting

- Fits for piccating rail
- Elevation adjustment at front- and rearsight
- Rearsight with windage adjustment
- Rearsight with different holes on revolving disc
- Option to mount a special iris-aperture
- Frontsight with light fibre element
- Crosshair can simple dismantled
- Milled body from reinforced aluminium
- Spindles, axles and clamp in steel

19077775

RRP in Euros: **439.00**



Shows optional extra Sight Tactic

FLIP-UP TACTIC

Precision-Flip-Up sight for sport-shooting

- Fits for piccating rail
- Rearsight with windage adjustment
- Rearsight with different holes on revolving disc
- Option to mount a special iris-aperture
- Milled body from reinforced aluminium
- Spindles, axles and clamp in steel

19077776

RRP in Euros: **365.00**



SIGHT TACTIC

Special-Iris aperature for centra Flip-up sights

- Adjustment range 0.8 – 2.2 mm

19077777

RRP in Euros: **103.00**



GOLIATH – FOR LONG RANGE ONLY



- Iris front Sight Ring Beam
- M30 (UN 1/4" – 28)

19600002	2.3-4.3
19600001	2.8-4.8
19600003	3.8-5.8
19600004	5.5-7.5
19600006	6.5-8.5
19600007	8.0-10.0



RRP in Euros: **159.00**

SUNSHADE

- Antiglare tube for Goliath
- Protection from light reflections and rain

19906319

RRP in Euros: **35.00**



EAGLE EYE GOLIATH

- With female thread for sunshade
- 0.3 and 0.5 available

19915510	0.3
19915511	0.5

RRP in Euros: **45.00**

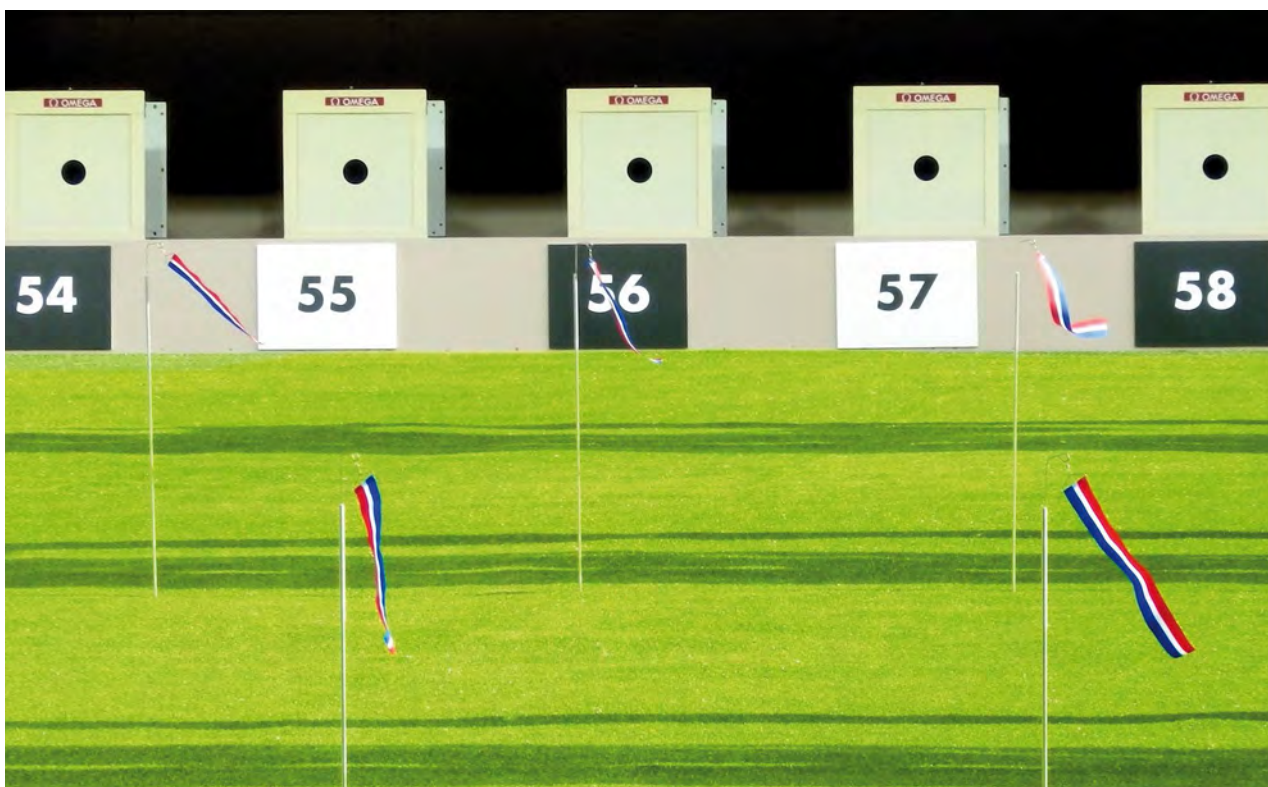

SCOPE TOOLS



SIMALUX 4 - 12 X 44 AO

- Lens diameter 40 mm
- Parallaxfree: 10 m to infinity
- 1 Click 1/4 MOA
- Weight: 555 g
- Including mount for 11 mm rail

19077772

RRP in Euros: 179.00

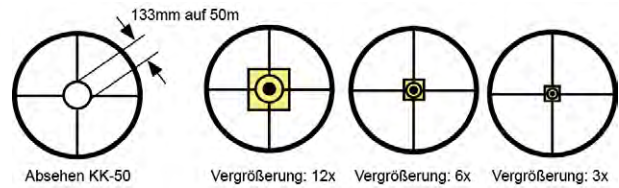

SIMALUX 3 - 12 X 44

- Lens diameter 44 mm
- Parallaxfree: 50 m
- 1 Click 1/4 MOA
- Weight: 590 g
- Including mount for 11 mm rail

19077773

RRP in Euros: 359.00



OUR NEW PRODUCT

Anschütz Telescope KK50 4-12X44 Ao can be found on **page 12**.





FILTER ZF

Filter system for Rifle-Scopes

- Consists of two parts (adapter and filter body)
- Easy to exchange the coloured glass

RRP in Euros: **69.00**

19940073	Yellow	
19940074	Peach	
19940075	Brown	
19940076	Dark Gray	
19940077	Green	



Adapter Zeiss



Adapter Simalux

ADAPTER

Filtersystem for Rifle-Scopes

RRP in Euros: **29.00**

19940071	Adapter Zeiss
19940072	Adapter Simalux

MICRO MOUNT

Special mount for scope

- Extra-large rail for individual position of the scope
- Precise adjustment from 50 m to 100 m using "new" click adjustment, custom setting option
- Weight: 170 g
- Height: 35 mm
- Fit for all common rifles



Shows optional extra scope tool 3 - 12 x 44

19940082

UVP in Euro: **209.00**

PERFECT SIGHT



2 SHOOTING GLASSES

- ⊙ ULTRA LIGHT
- ⊙ FRAME GLASSES
- ⊙ FRAME GLASSES STARTLINE
- ⊙ HEADBAND GLASSES
- ⊙ MONOCLE
- ⊙ SHIFT
- ⊙ SUPPORT SYSTEM
- ⊙ EYE BLINDERS
- ⊙ NOSE PIECE
- ⊙ IRIS UNIT AND FILTERS
- ⊙ SUITCASES
- ⊙ AXIA
- ⊙ TEARS AGAIN



JULIAN JUSTUS

Olympian 2012

1

2

3

4

5

6

7

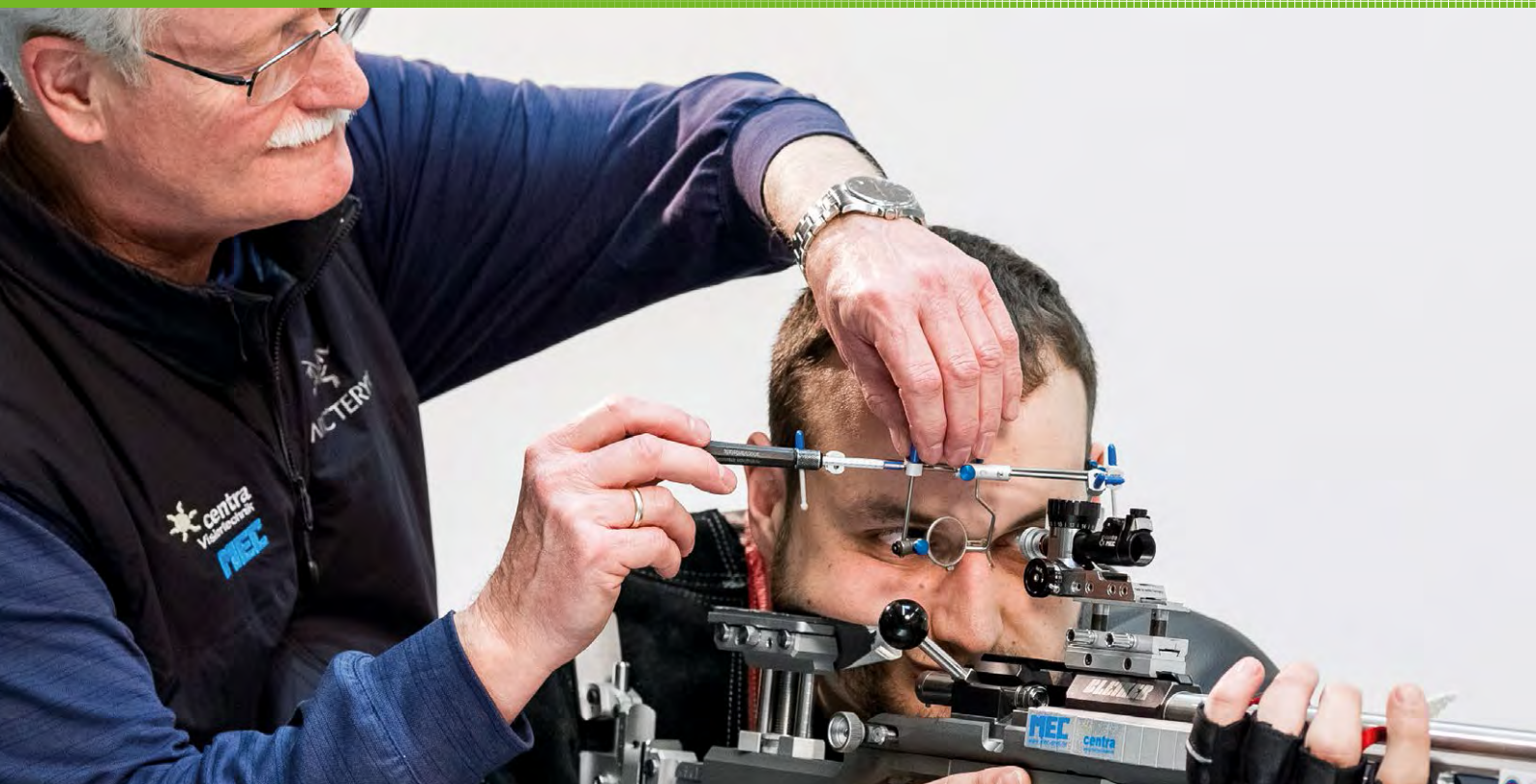

MEC GLAS SYSTEM

If the vision in your aiming eye is not corrected as appropriate to your gun and discipline, you will often find aiming a strenuous and sometimes unsteady affair. Your aiming eye may also fluctuate between seeing either the front sight or the target centre in sharp focus, which can lead to a rapid deterioration in visual acuity.

This is often followed by the following problems:

- You start to hold for longer (i.e. longer aiming time up until you fire your shot) because your eye isn't seeing things the way it should.
- You have to break off your shots more often, which puts you under time pressure and causes your visual acuity to deteriorate even further.
- This affects your confidence and can cause you to mess up crucial shots.

In cases like these, shooting glasses are a good solution in almost all disciplines. Given that shooting glasses need to incorporate a whole range of functions in a very small space, they are a challenging piece of equipment to design well. First and foremost, they have to be light, gentle on the skin, comfortable and easy to adjust. In short – you shouldn't know that you're wearing them.

Shooting glasses from MEC are a complete modular system that helps shooters with poor vision to achieve the best visual acuity they can.

THE MEC GLAS SYSTEM

This system offers virtually any shooter in almost any discipline a custom solution that will meet his or her requirements and wishes.

SHOOTING GLASSES AND PERFECT POSITIONING:

- When in position, THE SHOOTER'S AIMING EYE should be looking directly through the optical centre-point of the lens.
- THE CORRECTING LENS must be oriented 90° horizontally and vertically to the sighting line and be as close to the eye as the anatomy of the head (eyebrow and eyelashes) will allow.
- The shooter or coach should check that THE LENS is correctly positioned before every shooting session.

**PROFI
TIP**

MONOCLE

Since the start of the 2014 season, the rules of the German Shooting Sport and Archery Federation (DSB) have allowed shooters to permanently mount a shooting lens (such as the MEC glas Monocle or MEC glas Revolve) on their rearsight. This applies to all classes and all competitions run by the DSB. It is not permitted under the rules of the ISSF.

The shooting lens holder **MEC glas Monocle** and **MEC glas Revolve** are mounted on the rearsight with the enclosed tool and using an adapter fitting, a rod holder with clamping mechanism, a support rod for the lens

holder and a lens holder, as shown in the picture. The shooting lens – as in the case of shooting glasses – should be positioned directly in front of the eye (see picture).

Our recommendation: As far as possible, it's best to consult an optician who specialises in shooting when deciding between shooting glasses and a monocle. Since the lens strength and the shooter's position (canting) play a key role, you should consider all your options carefully – it's all too easy to rush in and make the wrong choice.



GOOD QUESTION...

I AM AN ARCHER, CAN I USE SHOOTING GLASSES, TOO?

Yes, but you need to take a lot of factors into consideration, and the devil is in the detail.

Firstly, it's important to know what lens strength you need and what kind of environment you will be in – do you shoot indoors or outdoors? Do you take part in static disciplines or do you shoot on a course? There are a whole host of questions, all of which can be answered with one simple system

THE MEC GLAS SYSTEM.

Various models with a range of nosepieces offer a wide selection and are sure to contain the perfect solution for your specific needs.





MEC GLAS FRAME GLASSES

The MEC glas frame glasses captivates with its material mix of titanium / aluminum / stainless steel and is also equipped with the MEC glas quick-link. Just like with the MEC glas frame glasses ultra light this frame offers the quick-link to incorporate the MEC glas support system and blinder, giving the user flexibility on the highest level. Again, all elements of this frame can be easily and steadily adjusted allowing the user precise adjustment for each shooting position.

The length adjustable side pieces have spring hinges and comfortable silicone sport ends to offer the user great comfort. Through their anatomically formed ends. Upon desire you may use the Ultra light with all current MEC glas nose pieces and MEC glas blinders.



MEC GLAS FRAME GLASSES

- Available as a right- or left-handed version
- Includes MEC glas support system in 23 mm or 37 mm
- Includes height-adjustable MEC glas nose piece

	right	left	
50302	-31	-35	23"
50302	-33	-37	37"

RRP in Euros: **189.00**



MEC GLAS FRAME GLASSES COMPLETE

- Available as a right- or left-handed version
- Includes MEC glas support system in 23 mm or 37 mm
- Includes height-adjustable MEC glas nose piece
- Includes MEC glas cover

	right	left	
50302	-30	-34	23"
50302	-32	-36	37"

RRP in Euros: **212.00**

Anatomically shaped sport temple tips for added flexibility and maximum comfort

Adjustable-length temples

Interchangeable MEC glas holder system

MEC glas lens holder

MEC glas central mount

Includes height-adjustable and changeable MEC glas nose piece

Interchangeable MEC glas blinder

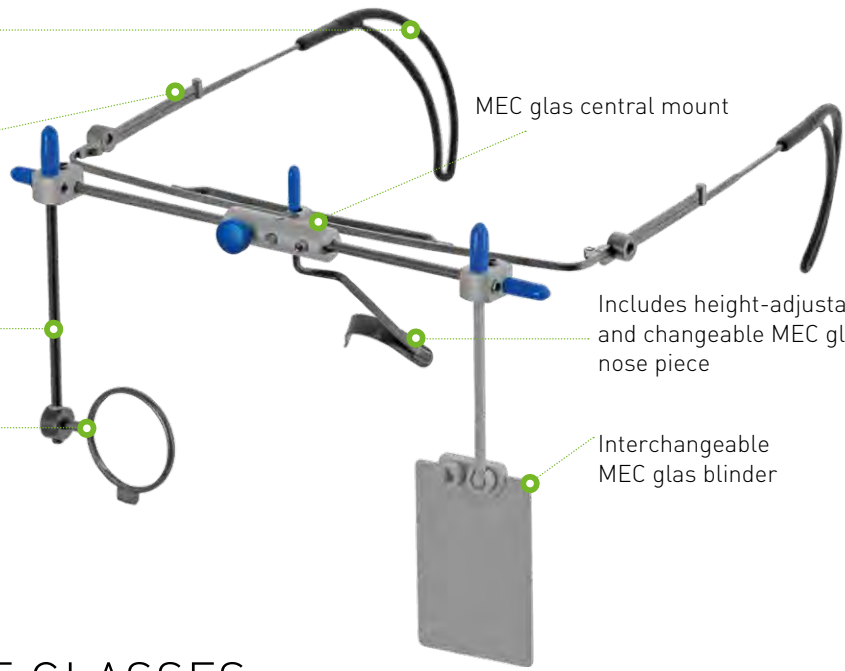

MEC GLAS FRAME GLASSES ULTRA LIGHT

The name says it – without attachments it weights only 13 grams. The frame glasses ultra light is manufactured from a mix of titanium, beta-titanium and aluminum. The quick-link for the MEC glas support system and blinders offers flexibility on the highest level. The easy and steady adjustment of all elements allows

the shooter to adjust the glasses individually to each shooting position. The length adjustable and highly flexible side pieces offer the user great comfort through their anatomically formed ends. Upon desire you may use the Ultra light with all current MEC glas nosepieces and MEC glas blinders.



MEC GLAS FRAME GLASSES ULTRA-LIGHT

- Available as a right- or left-handed version
- Includes MEC glas support system in 23 mm or 37 mm
- Includes height-adjustable MEC glas nose piece Ultra-Light

	right	left	
50299	-90	-94	23"
50299	-92	-96	37"

RRP in Euros: **224.00**



MEC GLAS FRAME GLASSES ULTRA-LIGHT COMPLETE

- Available as a right- or left-handed version
- Includes MEC glas support system in 23 mm or 37 mm
- Includes height adjustable MEC glas nose piece Ultra-light
- Includes MEC glas cover

	right	left	
50299	-89	-93	23"
50299	-91	-95	37"

RRP in Euros: **247.00**



MEC GLAS FRAME GLASSES STARTLINE

The MEC glas frame glasses startline is a simplified version of the frame glasses version. Despite the lower price this light weight offers quality on the highest level and can be upgraded with elements of the MEC glas

system at any time. It is also made of titanium, aluminum and stainless steel and is equipped with spring hinge sides and comfortable silicone sport ends.

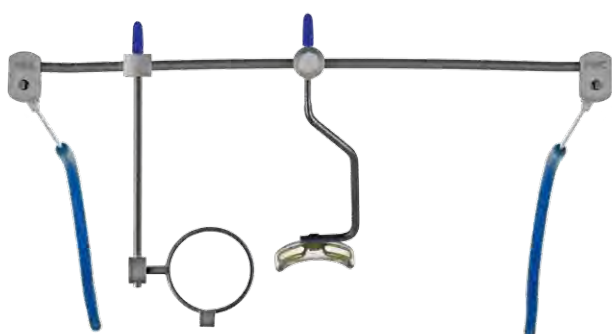

MEC GLAS FRAME GLASSES STARTLINE

- Available as a right- or left-handed version
- Includes MEC glas support system in 23 mm or 37 mm
- Includes height-adjustable MEC glas nose piece

System upgrades, optional:

- Quick-link for the MEC glas support system
- MEC glas blinder
- All current MEC glas nose pieces
- Length adjustable MEC eyeglas side pieces
- Eye blinder

	right	left	
50282	-06	-10	23"
50282	-08	-12	37"

RRP in Euros: 133.00

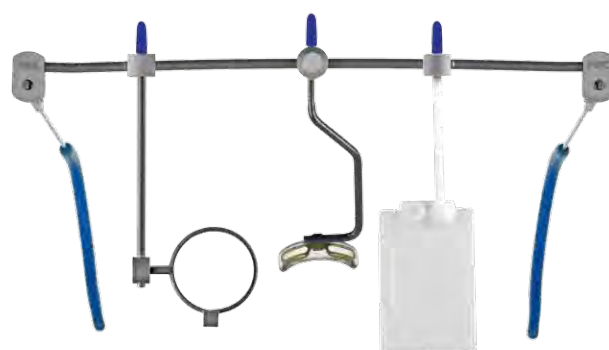

MEC GLAS FRAME GLASSES STARTLINE COMPLETE

- Available as a right- or left-handed version
- Includes MEC glas support system in 23 mm or 37 mm
- Includes height-adjustable MEC glas nose piece
- Includes MEC glas cover ISSF 30 mm, available in semi-transparent or grey

System upgrades, optional:

- See MEC glas Frame Glasses Startline

	right	left	
50282	-05	-09	23"
50282	-07	-11	37"

RRP in Euros: 156.00

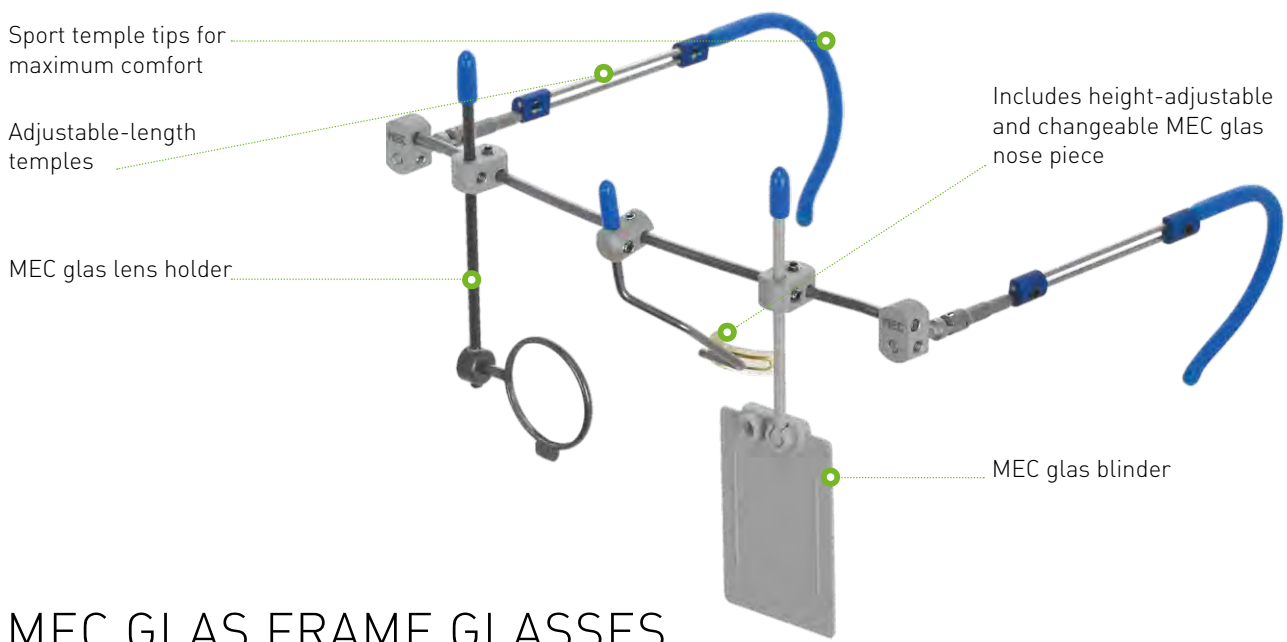

MEC GLAS FRAME GLASSES STARTLINE COMFORT

The MEC glas frame glasses startline comfort is the 'middle-class' model. The differences to the startline model are the adjustable side pieces with silicone sport

ends which offer the shooter more comfort. This frame is also made from titanium, aluminum and stainless steel.

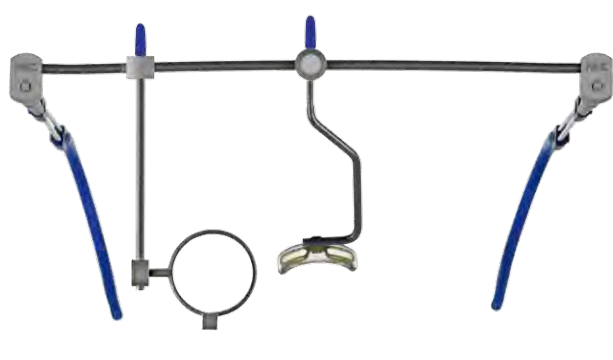

MEC GLAS FRAME GLASSES STARTLINE COMFORT

- Available as a right- or left-handed version
 - Includes MEC glas support system in 23 mm or 37 mm
 - Includes height-adjustable MEC glas nose piece
- System upgrades, optional:
- Quick-link for the MEC glas support system
 - MEC glas blinder
 - All current MEC glas nose pieces

MEC GLAS FRAME GLASSES STARTLINE COMFORT COMPLETE

- Available as a right- or left-handed version
 - Includes MEC glas support system in 23 mm or 37 mm
 - Includes height-adjustable MEC glas nose piece
 - Includes MEC glas cover ISSF 30 mm, available in semi-transparent or grey
- System upgrades, optional:
- Like MEC glas Frame Glasses Startline Comfort

	right	left	
50282	-14	-18	23"
50282	-16	-20	37"

RRP in Euros: **164.00**

	right	left	
50282	-13	-17	23"
50282	-15	-19	37"

RRP in Euros: **187.00**

MEC GLAS HEADBAND GLASSES

Our MEC glas headband glass is the alternative to the frames glasses version. The low-abrusion material mixture provides the user with extreme wearing comfort and conforms to the Öko-Tex Standard 100. The support is made from a special rubber band and its trimmings of easy-care amaretta.

The Velcro allows adjusting the glasses to the individual's head circumference. The exchangeable terrycloth inlet and the usual system upgrades such as the MEC glas blinders offers additional comfort.

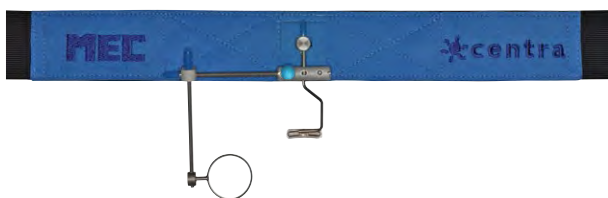

MEC GLAS HEADBAND GLASSES

- Quick-link for the MEC glas support system and blinder
- With MEC glas nose piece as a positioning aid
- Available as a right- or left-handed version
- Includes MEC glas support system in 23 mm or 37 mm

	right	left	
50304	-79	-83	23"
50304	-81	-85	37"

RRP in Euros: **189.00**

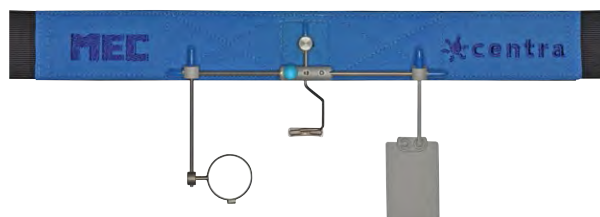

MEC GLAS HEADBAND GLASSES COMPLETE

- Like MEC glas Headband Glasses
- Includes MEC glas cover ISSF 30 mm, available in semi-transparent

	right	left	
50304	-78	-82	23"
50304	-80	-84	37"

RRP in Euros: **212.00**

MEC GLAS HEADBAND GLASSES STARTLINE

With the MEC glas headband glasses startline we have designed a simple system. The differences are the simplified MEC glas support system and the missing

positioning aid. In spite of the lower price you will find the usual MEC quality.

MEC GLAS HEADBAND GLASSES STARTLINE



- Available as a right- or left-handed version
- Includes MEC glas support system in 23 mm or 37 mm

	right	left	
50304	-67	-69	23"
50304	-68	-70	37"

RRP in Euros: **96.00**

THESE NEW PRODUCTS

can be found on **page 13**.



MEC Glas Monocle Revolve

No tools required when making adjustments.
Small, light, retrofittable.



Revolve

360-degree rotation enables perfect lens adjustment.

Configure your personal shooting glasses – including the lens!

www.mec-schiessbrille.de

MEC H.T.S.E. - Hannöversche Straße 22 - 44143 Dortmund - 0231-42 60 48 0



MONOCLE

From the start of the 2014 season, the official rules permit shooters to mount a lens from a pair of shooting glasses on their rear sights. This rule applies to all classes and all competitions regulated by the German Shooting Sport and Archery Federation.

Because the correction lens stays in exactly the same place in relation to the sighting line, this approach offers

a number of benefits for shooters who use relatively weak lenses and otherwise have no need for spectacles.

As the illustration shows, the Monocle mono-lens holder is fitted between the rearsight and rear iris using the tool supplied. It comprises an adapter fitting, a rod holder with clamping mechanism, a support rod for the lens holder and a lens holder.



MEC GLAS MONOCLE

- This stable and adjustable mounting device is used to fit a lens from a pair of shooting glasses in front of a rear iris
- The lens can be moved closer to, or further away from the eye
- Because the correction lens therefore stays in exactly the same place, perfectly positioned in relation to

the sighting line, this arrangement brings a number of benefits

- MEC glas Holder Adapters for Lens Holders and Lens Holders are 100 % compatible with the MEC glas Shooting Glasses System
- For beginners and professionals

5015532

23 mm

5015533

37 mm

23 mm: **RRP in Euros: 69.00**

37 mm: **RRP in Euros: 79.00**

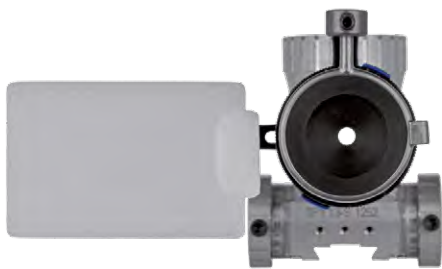

MEC GLAS MONOCLE DUO

- See Monocle
- Includes 30 mm translucent blinder
- Monocle Duo is available only in 23 mm

5000766

RRP in Euros: 129.50

MEC GLAS MONOCLE INDEX

The Index is the ideal accessory for shooters who don't want to have the Monocle lens holder permanently mounted to a rifle. It can be used to fit the lens holder to one or more rifles in next to no time, reproducing the same alignment every time with outstanding precision.

Important: The adapter fitting and rod holder must be fitted to the gun. These are available as individual parts.



5000901

RRP in Euros: 14.00

THE CORRECT DISTANCE

Distance eye to shooting glass about 15 mm
Distance eye to iris aperture from 40 mm to 70 mm

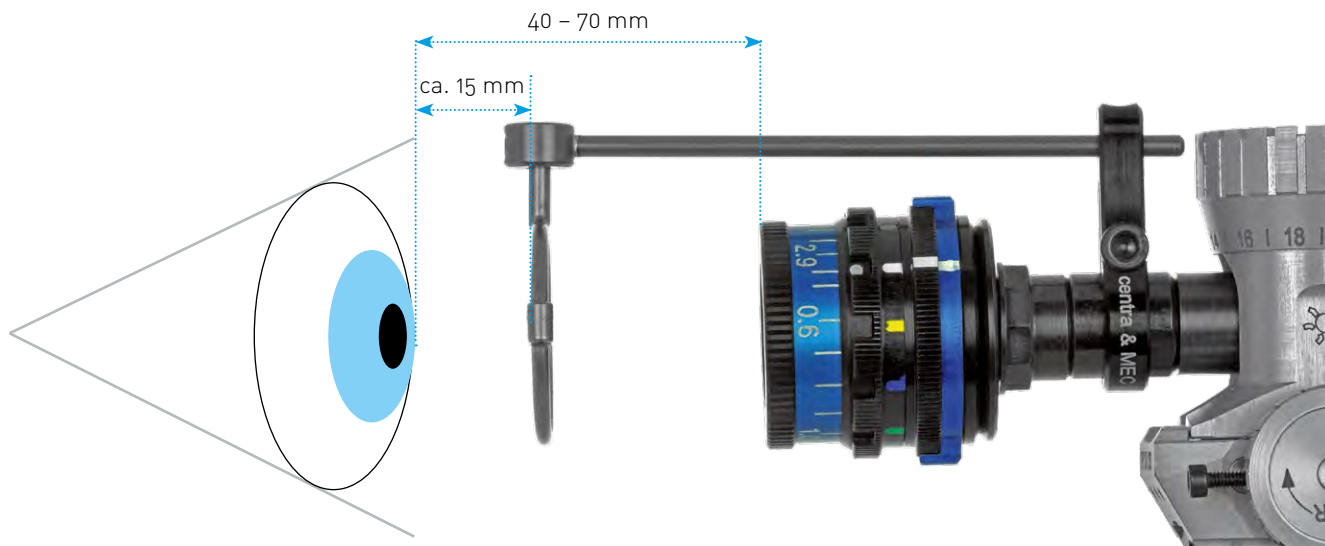

MEC GLAS SUPPORT SYSTEM

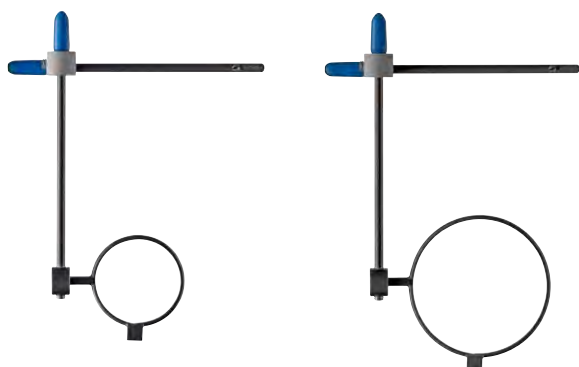

- Compatible with all MEC glas Glasses and MEC glas conversion kits with quick-link
- Precise settings of the shooting lens in 90° horizontal and vertical to the sight line
- Exact reproduction of the settings without additional means
- Colored end caps for easier allocating different disciplines, available colors: blue, red, yellow, green, black and grey
- Glass support ring in 23 mm and 37 mm

5010131

23"

5010132

37"

RRP in Euros: 37.00

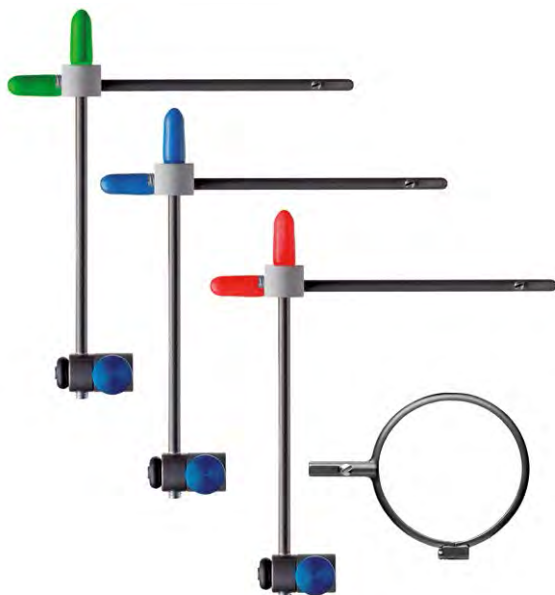

MEC GLAS GLASHALTE-SYSTEM 3-STELLUNG

- 3 MEC glas support systems for 3 positions, but only 1 glass holder
- Exact and lightning-fast exchange of the MEC glas support system during competitions
- Precise settings of the shooting lens in 90° horizontal and vertical to the sight line
- No new adjustments with tools necessary
- Fits all MEC glas Glasses and MEC glas conversion kits with quick-link
- Colored end caps for easier allocating different disciplines
- Glass support ring in 23 mm or 37 mm

5011352 . 3 Set with glassholder . 23"

RRP in Euros: 224.00

5011353 . 3 Set with glassholder . 37"

RRP in Euros: 224.00

5004058 . Holdings-system without glassholder

RRP in Euros: 65.00

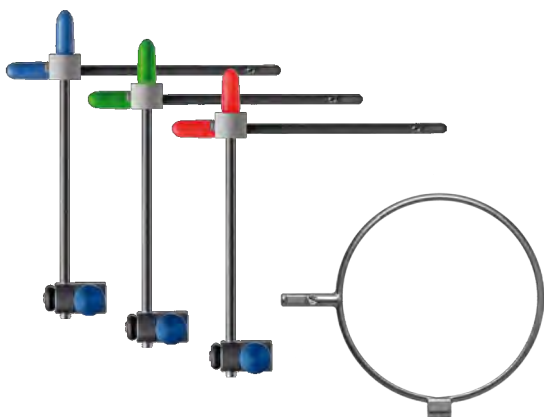

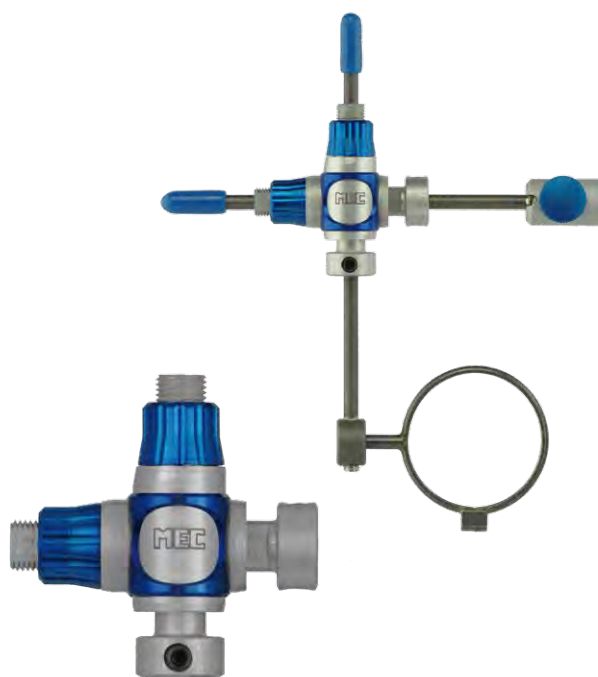

Picture shows additional items

MEC GLAS SHIFT

- Precision mechanics for height and side adjustment
- Easy adjust in position without tools
- Upgrade for all MEC glas Support System
- Attachable via adapter to almost all types of shooting glasses

5000871

RRP in Euros: 177.00



AXIA TRIPLE X SET

Solves vision- and aiming problems through its unique adjustment system of the shooting glass fine adjustment. Set includes:

- One adjustment system
- Three holding systems that can be used either for filters or additional correction glasses

Standard . 5000865
Champion . 5030679

RRP in Euros: 419.00

MEC GLAS EXCHANGE NOSE PIECES

MEC glas nosepieces are comfortable and can be adjusted to the anatomical characteristics of the nose. Despite their slender design, MEC glas nosepieces achieve optimum pressure distribution. What's more, the shape of the nosepieces also ensures that the

shooting glasses can be correctly adjusted. All MEC glas nosepieces are of course compatible with all MEC shooting glasses as well as various other brands. All nosepieces are suitable for use in all disciplines.

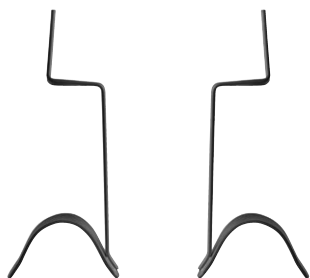

MEC GLAS NOSE PIECE ULTRA LIGHT

- Material: Grade 2 titanium and beta-titanium
- Anti-allergen and sweat resistant

	right	left
50155	-28	-29

RRP in Euros: 20.00



MEC GLAS NOSE PIECE

- Material: High-grade stainless steel
- Nose bridge: Transparent, odourless silicone rubber (polydimethylsiloxane)
- Anti-allergen and sweat resistant

	right	left
50155	-26	-27

RRP in Euros: 17.00



MEC GLAS NOSE PIECE WING

- Material: High-grade stainless steel
- Nose bridge: Transparent, odourless silicone rubber (polydimethylsiloxane)
- Nose bridge can be replaced

5015530	right
5015531	left

RRP in Euros: 17.00



MEC GLAS HEX KEY

- 6M key
- CV 1.5 mm, burnished
- Visible blade length 75 mm
- Printed with: www.mec-shot.de

5001045

RRP in Euros: 7.50



MEC GLAS IRIS APERTURE WITH HOLDER

- The best solution for pistol shooters
- Sizes 23 mm or 37 mm
- Sharpens perception of backsight, foresight and target
- Can be adjusted with one hand

5010168	23"
---------	-----

RRP in Euros: **48.00**

5010170	black 37"
5010169	translucent 37"

RRP in Euros: **50.00**



MEC GLAS MAGNETIC FILTERHOLDER

- Allows fast interchanging of magnetic filters

5010133 . 23"

RRP in Euros: **16.00**

5010134 . 37"

RRP in Euros: **44.00**

MEC GLAS MAGNETIC FILTERS

For the best sight quality!
Allows contrast enhancements and light attenuation:

- Different colour filters individually packaged
- Centra-quality
- Surface hardened and easy to clean
- Can be swapped in one step

23"

RRP in Euros: **40.00**

37"

RRP in Euros: **55.00**

23"	37"	Colour
5010135	5010145	● Yellow / Red
5010136	5010146	● Yellow / Green
5010137	5010147	○ Brown 20 %
5010138	5010148	● Brown 50 %
5010139	5010149	● Brown 65 %
5010156		● Brown 80 %
5010140	5010151	● Ochre 20 %
5010141	5010152	● Ochre 30 %
5010142	5010153	● Orange 30 %
5010143	5010154	● Amethyst 35 %
5010144	5010155	● Green 35 %

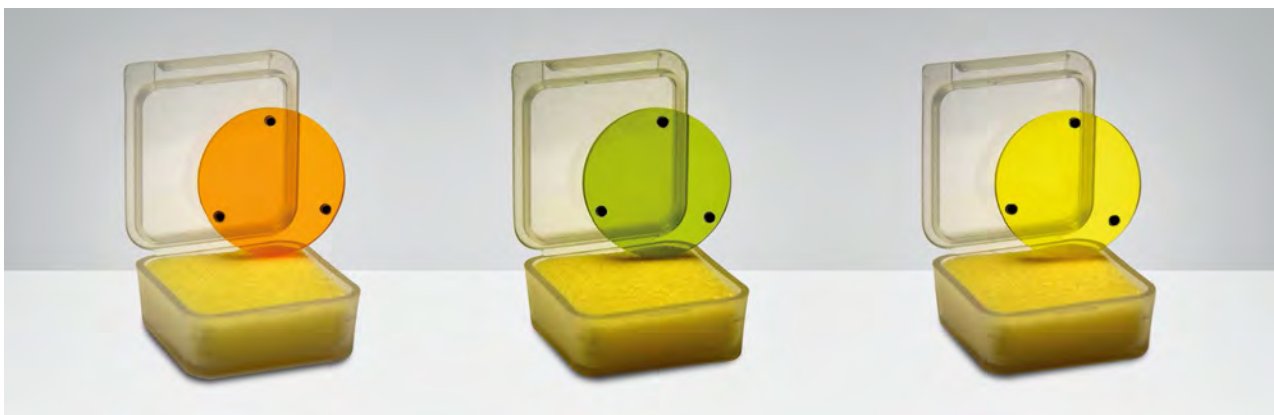

Product Examples



article 5028223

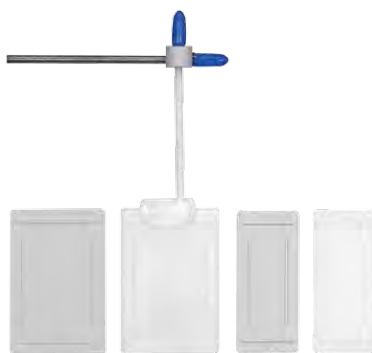

article 5028224



article 5028225

MEC GLAS EYE BLINDER ISSF WITH HOLDER

- Blinder with 4 different blinder plates
- In 19 and 30 mm with
- Transparent and grey

For shooting glasses of MEC eyeglass system, in the ISSF-permitted sizes.

5028223 . For Startline band / sweatband 19 / 30 mm translucent / grey

RRP in Euros: 25.00

5028224 . For frame glasses with a quick-link 19 / 30 mm translucent / grey

RRP in Euros: 24.00

5028225 . For Startline frame glasses 19 / 30 mm translucent / grey

RRP in Euros: 10.00



MEC GLAS EYE-BLINDER (PAIR)

- Allows comfortable adjustments while remaining in your position
- Available for all MEC Glas Glasses
- Compatible with other Models from Knobloch and Champion if used with the corresponding MEC eyeglass adapter
- Sizes according to ISSF regulations

A genius solution to cope with all contingencies and light conditions.

5010165 . for Ultra light, Frame Glasses Startline Comfort

5010166 . for Startline

RRP in Euros: 22.00

5010167 . for Headband

RRP in Euros: 28.00



Picture 1 . 5010165

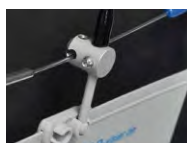

Picture 2 . 5010166



Picture 3 . 5010167



Article 5000909

ADAPTER FOR FRAME GLASSES (1 PAIR)

from Knobloch, Champion and Stadler

5000909 . MEC Glas Adapter for Champion Olympic

RRP in Euros: 24.00



Article 5000910

5000910 . MEC Glas Adapter for Knobloch, Champion World and Stadler

RRP in Euros: 15.00



SEE BETTER WITH JUST ONE SPRAY! TEARS AGAIN

When results start to drop and aiming becomes exhausting, talk soon turns to glasses, front sight and filters. "Have I really got the best solution on the market, or is there something new out there that could give me a clearer view?"

But at those tough times when shooters start to think like this, they often completely forget about the thing that matters most of all – the eye itself! It all comes down to what you expect from it. If you fix your gaze intently on the target, it won't take long before your visual acuity starts to decline. That's because exhaustion will start to set in in the muscles around your eyes and the

chemical reactions in your retina. However, there are a few simple rules that can help to combat fatigue and they are worth memorising:

- Never spend more than 4 – 8 seconds aiming at the target
- Relax your eyes between shots by looking at grey areas without focusing
- Avoid looking at lights or bright surfaces
- Use a visor and blinders to block out disruptive light
- Try a liquid spray to help you overcome fatigue



TEARS AGAIN

Eye spray with natural lipids for the repair of your tear film. Eliminates discomforts such as itching, burning and dry eyes. The spray is simply sprayed onto the closed eyelid. The effect begins after approximately 4 minutes and lasts for 4 hours.

Base price: 100 ml = Euros 135.00

5010192 . 10 ml

RRP in Euros: 13.50

5010193 . 20 ml

RRP in Euros: 22.50

MAXIMUM INDIVIDUALITY



3 MARK | STOCKS

- ⊙ AIR RIFLE STOCKS
- ⊙ SMALLBORE STOCKS
- ⊙ STARTLINE STOCKS
- ⊙ MARK | ACCESSORIES

AMELIE KLEINMANN

European Champion 2012



- 1
- 2
- 3
- 4
- 5
- 6
- 7



MARK I – CUSTOM SOLUTIONS FOR EVERYONE

The grips in the MARK I range offer maximum adjustment options. The grip can be moved up, down, left, right, forward and back and, thanks to a ball joint, it can also be rotated and tilted freely. The grip is available in three different sizes and its wooden body features an optimum coating – all of which makes it easier for shooters to find the ideal position.

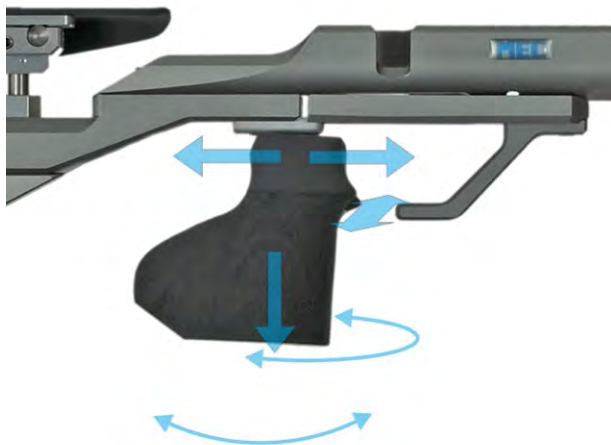

Another detail of the MARK I range is that the stocks can be “disassembled”. The air rifle and smallbore frames can be separated, leaving behind the rear stock and grip with all its setting and adjustments intact and unchanged. This means, for example, that shooters can use a selection of rear stocks when changing between positions or from supported shooting to the standing position. What’s more, thanks to the MEC Mark I Coupling Speed, shooters can change their rear stock in a matter of just a few seconds. This is a major advantage in the finals, when it doesn’t just come down to every tenth, but to time, too.



Stock changeover in merely a few seconds – 1, 2, 3, ready!

A tip from the coach:

Take up your position, close your eyes and focus on your hand and the trigger. Make sure you have a strong enough hold on the grip and feel whether your finger is straight as it reaches the trigger lever. Now, gently increase the pressure on the trigger and then lower it again. Your finger shouldn't change position as you do this. Getting your hand and trigger finger into the ideal position is very important for the stability of your position and the precision of your trigger release. The experts invest hours in getting their grip and trigger blade into the ideal position. Often, they will readjust these positions slightly before a match to take into account their form on the day.



The Support is a hand rest that can be moved forward, back, up and down. However, two separate "rails" can also be moved to the side, so that the width of the rest can be asymmetrically adjusted. These adjustment options ensure the rest can be adapted precisely to the wide range of hand and fist postures that shooters adopt.

Shooters who have been using their rifle for years and spent many intense hours of training and competition time working on it learn to appreciate carefully thought-out elements. Indeed, new solutions that resolve old problems can trigger astonishing progress, making shooting an even more enjoyable and rewarding experience. The MARK I contains just such solutions.

The butt plate, cheekpiece, grip and fore-end stock have all been designed by MEC and centra. They have been specially developed and tested for the new stocks.



We are confident that they offer distinct advantages over existing models and have therefore adapted them to other rifles. Rifle shooting is indisputably a sport where your equipment is crucial. In fact, the increase in scores across all classes is closely linked to improvements in equipment. Even shooters who aren't determined to be the best of the best will still enjoy making progress and being able to hold their own against the competition. In this regard, the stock is an absolutely crucial factor.

Only a stock in the correct proportions will enable a shooter to adopt stable positions and only effective adjustment mechanisms will help him or her react rapidly. It is astounding how often we find that a new stock can eradicate long-standing problems in clubs and teams.

And that in turn unlocks fresh enthusiasm and drive.



AIR RIFLE



MEC MARK I

Standard colour, hard-coated/grey

- Special stock for air rifle standing
- Aluminium and stainless steel; solid, machined and hardened
- Exceptionally adjustable from within the position
- Cheekpiece adjustability, also slides back and forth
- Ball-joint for the grip, adjustable back/forth, up/down and sideways; specially coated wood, 3 sizes
- Demountable butt end and grip (for travelling)
- Vibration damping between fore-end and butt
- Variable hand-shelf Support

Mark I + Order Information

RRP in Euros: 1578.00



MEC MARK I ROTATION I

Standard colour, hard-coated/grey

- See Mark I
- Modular system, for shooter all age from youngster up to the rests shooting senior
- Flexible adjustment of the forend stock
- High-quality material, aluminum-anodized, stainless steel
- The rifle action can be easily exchanged

Mark I Rot I + Order Information

RRP in Euros: 1578.00

COLOURED ANODISED COATINGS

Anthracite /
 Blue /
 Gold /
 Lilac /
 Red /
 Black /
 Silver

RRP in Euros: 100.00

! See **page 113** for information on placing orders.

1

2

3

4

5

6

7

AIR RIFLE SUPPORTED



MEC MARK I AGL

Standard colour, hard-coated/grey

- Stock for air rifle supported
- Extended, wider, rotatable fore-end
- Fully adjustable grip
- All elements can be adjusted in position
- Free variation of weight distribution to muzzle
- Extended cheek-piece, set back
- Easy build-back to a standing stock
- For all well-known air rifle actions

Mark I AGL + Order Information

RRP in Euros: 1849.00



MEC MARK I ROTATION I AGL

Standard colour, hard-coated/grey

- See Mark I AGL
- Flexible and freely adjustable fore-end stock system
- Different length possible
- Shooting rest position can be chosen arbitrarily
- Stainless steel, aluminumodized and special coated

Mark I Rot I AGL + Order Information

RRP in Euros: 1849.00



SMALLBORE RIFLE



MEC MARK I.22 (INCL. FREE POSITION II)

Standard colour, hard-coated/grey

- Inclusive of Free Position and Handstop
- The optimum for the ambitious smallbore shooter
- All the advantages of the air rifle stock, in addition to which the complete butt-end with grip can be swapped between the positions
- Can at any time be set up for shooting in supported mode

Mark I.22 + Order Information

RRP in Euros: 1829.00



MEC MARK I.22 ROTATION I (INCL. FREE POSITION II)

Standard colour, hard-coated/grey

- See Mark I
- Mark I stock with stainless-steel guide tube in the front
- Free movement of the hand piece, also while in shooting position
- Altered vibrations, expedited modification possible
- through fast exchanges of components for prone, standing, and kneeling
- Stock with carbon extension tube
- Smallbore aluminum stock guide tube in the front with butt plate and Handstop

Mark I.22 Rot I + Order Information

RRP in Euros: 1829.00



MEC MARK I.22 ROTATION II (INCL. FREE POSITION II)

Standard colour, hard-coated/grey

- See Mark I
- Like Rotation I with stainless steel extension tube
- Please specify the barrel diameter

Mark I.22 Rot II + Order Information

RRP in Euros: 1829.00

1
2
3
4
5
6
7

SMALLBORE RIFLE SUPPORTED



MEC MARK I.22 AGL

Standard colour, hard-coated/grey

- Inclusive of Free Position AGL, Fore-End Extension and Support rail
- Optimal butt design achieved through the multi-adjustable buttplate and the long, movable cheekpiece
- The fore-end is extended about 15 cm and together with the support rail, comes an extremely long way forward

Mark I.22 AGL + Order Information

RRP in Euros: 1949.00



MEC MARK I.22 ROTATION I AGL

Standard colour, hard-coated/grey

- Inclusive AGL Free Position
- Flexible and freely adjustable forend stock system
- Different length possible
- Rest position can be arbitrarily adjusted
- Stainless steel, aluminumanodized and special coated
- Stock with carbon extension tube

Mark I.22 Rot I AGL + Order Information

RRP in Euros: 1949.00

PRICE WITHOUT MEC FREE POSITION II

RRP in Euros: -369.00

PRICE WITHOUT MEC HANDSTOP

RRP in Euros: -109.00

ADDITIONAL COST COLOURED

- Anthracite / ● Blue / ● Gold / ● Lilac / ● Red / ● Black / ● Silver

RRP in Euros: 100.00

MEC MARK I STARTLINE SERIES

- Extremely lightweight design
- Low price offer a favorable entrance into the Mark I world with the usual MEC-quality
- Stocks can always upgrade with individual elements of the Mark I system
- Materials: aluminum and stainless, by all Comfort versions also carbon
- Solid, milled and hardened
- Available for air rifle and small bore rifle
- Delivery without butt plate
- 3 grip sizes selectable



MEC MARK I STARTLINE BASIC

Standard colour, hard-coated/grey

- Butt is length adjustable and can be pivoted
- Cheek piece and grip are height adjustable and can be pivoted laterally

Mark I Start Basic + Order Information

RRP in Euros: **949.00**



MEC MARK I STARTLINE BASIC AGL

Standard colour, hard-coated/grey

- Like Mark I Startline Basic
- Special stock for rifle supported
- Elongated, wider, revolvable fore-end

Mark I Start Basic AGL + Order Information

RRP in Euros: **1200.00**



See **page 113** for information on placing orders.



1
2
3
4
5
6
7

MEC MARK I STARTLINE COMFORT

Standard colour, hard-coated/grey

- Butt is length adjustable and can be pivoted and can be canted
- Grip with ball joint are length, height and side adjustable
- Cheek piece is height and side adjustable and can be canted

Mark I Start Comfort + Order Information

RRP in Euros: 1099.00



MEC MARK I STARTLINE COMFORT AGL

Standard colour, hard-coated/grey

- Like Mark I Startline Comfort
- Special stock for rifle supported
- Elongated, wider, revolvable fore-end

Mark I Start Comfort AGL + Order Information

RRP in Euros: 1350.00



MEC MARK I ROTATION STARTLINE BASIC

Standard colour, hard-coated/grey

- Flexible adjustment of the front stock
- Butt is length adjustable and can be pivoted
- Cheek piece and grip are height adjustable and can be pivoted laterally

Mark I Rot Start Basic + Order Information

RRP in Euros: 949.00



MEC MARK I ROTATION STARTLINE BASIC AGL

Standard colour, hard-coated/grey

- Like Mark I Startline Basic
- Special stock for rifle supported

Mark I Rot Start Basic AGL + Order Information

RRP in Euros: 1200.00



MEC MARK I ROTATION STARTLINE COMFORT

Standard colour, hard-coated/grey

- Flexible adjustment and weight shift of the front stock
- Grip with ball joint are length, height and side adjustable
- Butt is length adjustable and can be pivoted and can be canted
- Cheek piece and grip are height adjustable and can be pivoted laterally

Mark I Rot Start Com + Order Information

RRP in Euros: 1099.00



MEC MARK I ROTATION STARTLINE COMFORT AGL

Standard colour, hard-coated/grey

- Like Mark I Startline Comfort
- Special stock for rifle supported

Mark I Rot Start Com AGL + Order Information

RRP in Euros: 1350.00

ORDER INFORMATION

What the customer / dealer should specify:

1. Which Mark I stock is required?
2. Is it for supported or unsupported shooting?
3. Is the shooter right or left-handed?
4. Which system/model is the stock going to be used with?
5. Air rifle or smallbore?
6. Butt plate length: 120 mm or 140 mm?
7. Which cheekpiece is required? Supported (R/L) or unsupported (R/L)?
8. What grip size is required? Right (S, M, L) or left (M)?
9. What colour should the stock be?

Compatible models:

Air rifle: – FWB 700 + 800, P 70
 – Anschütz 2002 P, 8002, 9003
 – Walther LG 300 / XT, LG 400

Small bore: – FWB 26XX, 2700
 – Anschütz 19XX / 29XX
 – Walther KK 200 / 300
 – Bleiker Challenger

Other models on request.

COLOURED ANODISED COATINGS

● Anthracite / ● Blue / ● Gold / ● Lilac / ● Red / ● Black / ● Silver

THESE NEW PRODUCTS

can be found on **pages 16-17**.



MEC Project

Uncompromising in production, functionality, anatomy and design.



MEC Project Evolution

New system mount based on 2 clamping elements.

MARK I STOCKS



MARK I COUPLING SPEED

- Allows rapid changeover between different rear stocks
- Easier to fit and more secure, no tools required
- Modified for the new rules that apply to finals

5000742

RRP in Euros: **100.00**



Please specify „includes Mark I Coupling Speed“ with your stock order.



MARK I LINK

- Butt plate can be adjusted with millimetre accuracy
- Can be adjusted in stance, no tools required
- Continuous, stepless adjustment
- Can be offset up to 16 mm to either side
- Available in aluminium or steel
- Lengths: 55 mm or 25 mm

5000746	Mark I Link I – short
5000747	Mark I Link II – long
5000748	Mark I Link plate – short
5000749	Mark I Link plate – long

Link Short



Link Long



Mark I Link: **RRP in Euros: 267.00**

Plate: **RRP in Euros: 68.00**



SIDE ARM FOR MARK I

Stainless steel side arm for Mark I Air rifle/smallbore

- Incl. 3 pushbolts and screws
- Incl. 2 screws M5x8 and washers

6600032 . KK . stainless steel

RRP in Euros: 69.00



GRIP MARK I

- Anatomically formed pistol grip from special-coated laminated wood
- Compatible with all Mark I stocks
- FWB 700, Anschütz, and WALTHER require special adapter „Mounting Kit“

5015513	S
5015514	M
5015516	L
5015515	left M

RRP in Euros: 178.00



MOUNTING KIT

- Mount compatible for WALTHER
- Anatomic laminated wood grip

5010086	FWB
5010087	WALTHER
5010085	ANSCHÜTZ
5010088	ANSCHÜTZ PRECISE

RRP in Euros: 99.00

PUSH-UP



PUSH-UP

- Fore-end raiser aluminium 2.5 cm
- For use in the prone and kneeling positions by shooters with short lower arms

5004011

RRP in Euros: 179.00



PUSH-UP ADJUSTABLE

- Fore-end raiser, turnable

5004008

RRP in Euros: 239.00



PUSH-UP DELUXE

- Fore-end raiser, turnable
- Up and down

5004010

RRP in Euros: 269.00

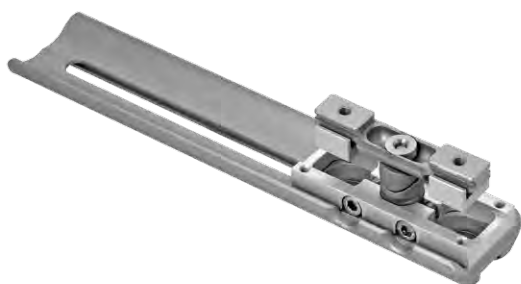

PUSH-UP DELUXE EXTREME

- Fore-end raiser turnable
- Up and down
- Canting

5004012

RRP in Euros: 299.00

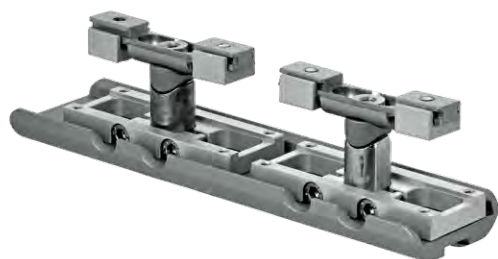

PUSH-UP DELUXE EXTREME STRONG

- Fore-end raiser turnable
- Up and down
- Canting
- With two holders

5004020

RRP in Euros: 449.00



1

2

3

4

5

6

7

SUPPORT



SUPPORT

- Adjustable Alu-Handpiece with 2 variable elements
- For stocks with profile rails

5004004

RRP in Euros: 139.00



SUPPORT II

- Turnable

5004005

RRP in Euros: 189.00



SUPPORT III

- Turnable
- High variation

5004006

RRP in Euros: 229.00

TANGIBLE ADVENTAGE



4 ACCESSORIES

- ⊙ FOR RIFLES
- ⊙ FOR 3-POSITION
- ⊙ FOR SUPPORTED SHOOTING
- ⊙ FOR PISTOLS
- ⊙ FOR EVERYONE

1

2

3

4

5

6

7

NICCOLO CAMPRIANI

Olympic champion 3 X 40 2012



THE MEC VISOR

Shooters often underestimate just how important it is to block out dazzling light and distracting noises during a match. Both these factors are problematic for shooters because they disrupt their concentration, which leads to “slip-ups”, poor reactions and inadequate follow-through. That is why experienced competitors spend a lot of time getting their earplugs, visor and blinders just right as they prepare to compete. However, this act of shutting yourself off from the outside world also has an important psychological effect. It focuses your attention on what really matters and pushes everything else into the background

Shooters who clean the barrel of their air gun very thoroughly – using chemicals and a brass brush, for example – should expect that they will have to fire 20 – 30 shots afterwards before they regain optimum accuracy. Consequently, you should carry out such drastic treatments before a training session.

BARREL CLEANING

Air rifle and air pistol shooters often completely underestimate how important it is to clean the barrel of their gun. To cover all eventualities, you should make it second nature to clean your gun after every shooting session, before you pack it away. Felt mops are the best thing to use because, once you’ve pulled them through, you can



clearly see whether the inside of your barrel is spotless. The most sensitive part of your barrel is the muzzle, so never clean from the front without taking precautions!



TRAINER TIP

A tip from the coach:

An ammunition test is a good opportunity to get to know how best to clean your gun. First, let a good amount of dirt accumulate by leaving your barrel uncleaned until you’ve fired 200 shots, then shoot 1 – 2 shot groups at the test range. After that, clean your barrel, looking very closely at the first three mops. Next, shoot two more groups with the same ammunition and compare the results with the shot groups from earlier. Many shooters think that tight-fitting cleaning aids are more effective. However, in our experience, there is little to be gained from being very forceful. A moderate and even force is quite enough. One thing is certain: When it comes to the highest scores – like those notched up by the very best shooters and in supported shooting – cleaning is a decisive factor. Every second shot that lands on 9.9 could be down to dirt...

BARREL EXTENSIONS

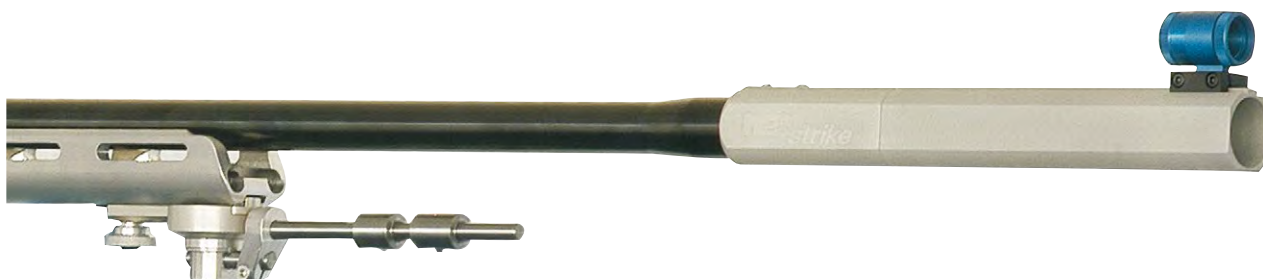

The longer a pendulum is, the slower it swings from one extreme to the other. The heavier it is, the more stable its path. Those are two simple rules of physics. A barrel extension is a mechanical means of transferring these principles to a rifle. Variable weights allow shooters to fine-tune the effects to suit their requirements. Even minor changes to the length and weight of the sleeve can have astonishing effects. In fact, it is an option that no competitor should ignore. Indeed, when it comes to supported shooting and the prone position, every gram that a shooter can add to his muzzle counts.

If at all possible, you should use SCATT so that you can closely inspect the final stretch of the green trace and the yellow trace. The ideal ratio of horizontal movement to vertical movement is around 100 to 80. If you find you're moving further to the sides, you should add some weight to your muzzle. If you find you're losing height too quickly, take some of the weight off. In smallbore shooting, particularly in the prone position, virtually all shooters use an extension sleeve.



Unfortunately, standard products rarely meet expectations, so much so that the best shooters almost always use 'home-made' solutions. Until now, special solutions such as these have been very expensive and time-consuming. The sleeves are usually also very complicated to clean and fit.

After a lot of in-depth experimentation, MEC has developed a highly practical high-precision sleeve – the **MEC Berta II**. The framework is fixed firmly in place just once and the sleeves that are inserted into it are easy to clean. There is plenty of space in your case.

If you experience a lot of side-to-side movement, or your shot groups show a clear horizontal distribution, it is well worthwhile experimenting with a weightier barrel.





FOR RIFLES



MEC CONTACT III

- Classic mature in silence
- Adjustable in every position
- Both wings turnable
- Very good hold
- Rounded edges
- Good accessible screws
- Revised version
- Fits all current match-rifles

5000054

RRP in Euros: 169.00



MEC CONTACT IV

- The classic has been modified to fit the new generation
- A hand adjustable screw enables vernier height adjustment
- Additional joints allow for variable adjustments
- Wing forms are exchangeable
- Wings are fully adjustable and revolable
- The natural uncured rubber knops allow for perfect grip
- Compatible with all common match rifles
- Suitable for the following disciplines: offhand air rifle, 3-position and shooting air rifle off a rest
- With MEC Hook expandable

5000062

RRP in Euros: 348.00



WHILE STOCKS LAST!

MEC FREE POSITION

- Butt plate for Super-Match and sport guns
- Uncountable possibilities of variation
- Wing elements allow it to be placed up high, at an angle and rotate around the axle
- Fits all current KK sport rifles
- Inclusive MEC Hook

5000032

RRP in Euros: 269.00

THESE NEW PRODUCTS

can be found on pages 18 – 19.

NEW



Führungsplatte lang für C4-CIV



Contact IV Light

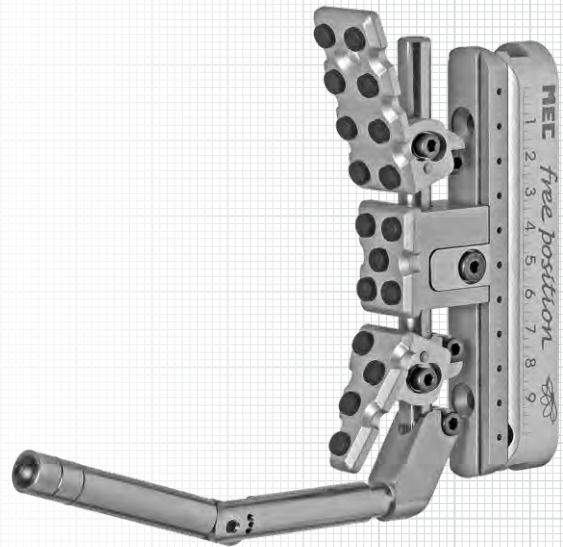

Free Position II



Stütze

A wide range of add-ons offer even more flexibility!

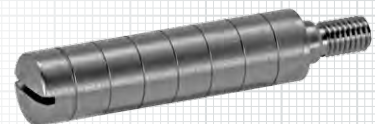

Stange Contact IV



Shows MEC Stange on MEC Free Position

MEC POLE

- Additional component to Free Position
- Grooved rod that allows to align individual Free Position elements
- Offers more exact setting options and improves the stability of the hook

5000048

RRP in Euros: 31.00



MEC CONROD

- Additional component to Free Position
- Socket allows the the adjustment of the hook to the side
- Offers various adjustment options for prone shooting

5000049

RRP in Euros: 74.00



MEC HOOK

- Stainless steel and aluminium
- Can be mounted to the MEC free position and the MEC Contact IV
- Two movable hook-elements
- Pivotal
- Can be extended
- Delivered unassembled

5000045

RRP in Euros: 62.00



RUBBER KNOP BLACK (prize / piece)

- Sparepart

5002491

RRP in Euros: 0.30



CHEEK

Millimetric adjustable cheekpiece

- Can be changed in position without a tool
- Ergonomic Profile
- Skin-friendly anti-slip surface

19950003*	FEINWERKBAU, ANSCHÜTZ, WALTHER
19950004	WALTHER CARBONTEC und PROTOUCH
19950005	ANSCHÜTZ 1813, Woodenstock

*Adjustment with clicks

RRP in Euros: 259.00



CHEEK PRO

- Like Cheek but with variable add-on weights for Mark I stocks and cheekpiece "Cheek" made of stainless-steel
- Asymmetric base rod
- Set consist of 1 rod (34 g) and 2 weights (à 27 g)

19950006*	FEINWERKBAU, ANSCHÜTZ, WALTHER
-----------	--------------------------------

*Adjustment with clicks

RRP in Euros: 299.00



BALANCE CHEEK

- Set consist of 1 rod (34 g) and 2 weights (à 27 g) without Cheek
- Also compatible with Final Kit Walther

5000644	Set
---------	-----

RRP in Euros: 43.00

5000643	Add-on weight
---------	---------------

RRP in Euros: 15.00



FINAL KIT WALTHER-ANATOMIC

Screw-kit and special clamp for WALTHER ANATOMIC to change cheek piece and buttplate very fast during the new ISSF finals

- Delivery: 1 x Thumbscrew with plastic tip to change the cheek piece very fast, 2 x adjusting nut (with plastic-tip) to safe position of the nut, 1 x safety clip to fix the position of the buttplate rods

19917980

RRP in Euros: 83.00



MEC TRIGGER I

- Trigger blade with ball and socket joint
- Rotatable on the side
 - Trigger moves freely
 - Horizontal ridges for safe adhesion
 - Optimal width
 - Variable rings for range perception
 - Light weight aluminum for proper function and stable fitting

5009939	FEINWERKBAU
5009940	ANSCHÜTZ
5009941	WALTHER
5009942	STEYR
5009943	HÄMMERLI

RRP in Euros: **90.00**



MEC TRIGGER II

- Trigger-Lever in aluminium
- Short version with pyramid-structure
 - Rotatable with ball-joint
 - Rubber cross-rings
 - Permits fully free movement
 - To be positioned vertically at the point of break

5009944	FEINWERKBAU
5009945	ANSCHÜTZ
5009946	WALTHER
5009947	STEYR
5009948	HÄMMERLI

RRP in Euros: **90.00**



MEC TRIGGER STARTLINE

- Trigger-lever in alu and plastic
- Rotatable around the centre pin
 - 3 height adjustments
 - Positioning exact under the barrel

5003508	FEINWERKBAU
5003509	ANSCHÜTZ
5003510	WALTHER
5003511	STEYR
5003512	HÄMMERLI
5003513	ANSCHÜTZ OFFSET

RRP in Euros: **32.00**

THESE NEW PRODUCTS

C.G Modell 22 Universal Match and Sport Trigger
can be found on **page 22**.

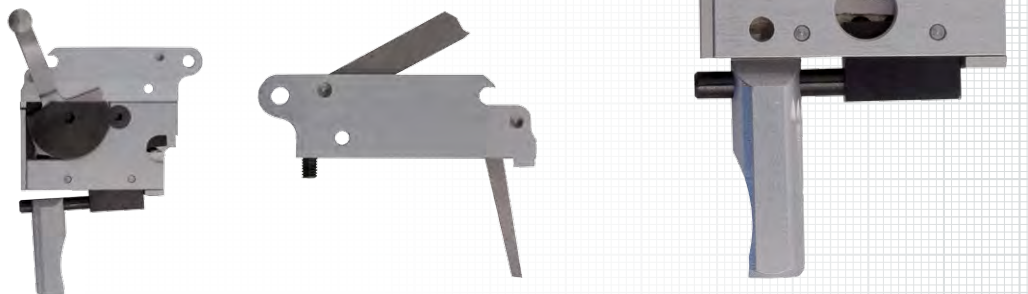

NEW

MEC TUBE

- Line of sight extension for air guns
- Extends the line of sight to its maximum
 - Infinitely variable line of sight variations
 - Variation of the weight and balance
 - Reduces the kick back



5026109	ANSCHÜTZ 2002
5026110	ANSCHÜTZ 8002 / 9003
5026111	FEINWERKBAU
5026112	WALTHER

RRP in Euros: 90.00

MEC TUBE XL

- The long tube for FEINWERKBAU rifles
- Till 85 cm system-length for more accurate aiming
 - Like above
 - Length 250 mm
 - For FWB Juniors-rifle



5026108	FEINWERKBAU
---------	-------------

RRP in Euros: 90.00

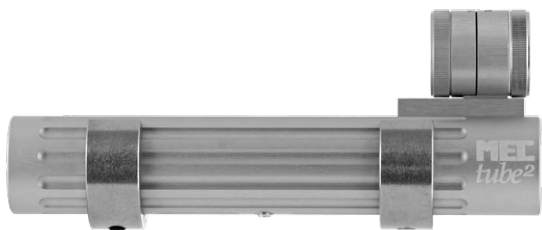

MEC TUBE II

Alloy barrel tube extension with integral foresight tunnel. Functions see „Tube“

- Foresight tunnel is moveable in a T-nut system
- No optical distortion
- A quality sight picture
- Complete with two moveable tube weights, and a 4 mm rear sight raising block

M 18	M 22	
19907402	19907405	ANSCHÜTZ
19907502	19907505	FEINWERKBAU
19907602	19907605	WALTHER
19907702	19907705	STEYR

RRP in Euros: **169.00**

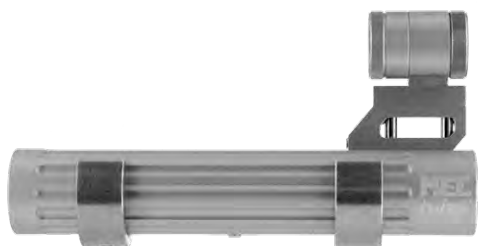

MEC TUBE II HR

Extension tube for air rifle competitors

- Incorporates all of Tube and Tube II features
- Front globe sight is vertically adjustable from 18 mm to 27 mm in 1 mm increments

M 18	M 22	
19907412	19907415	ANSCHÜTZ
19907512	19907515	FEINWERKBAU
19907612	19907615	WALTHER
19907712	19907715	STEYR

RRP in Euros: **249.00**

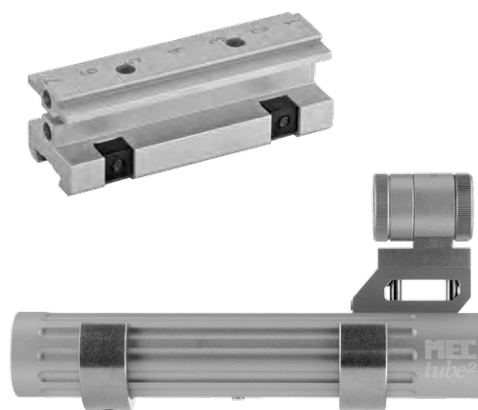

MEC TUBE II HR INCL. BLOCK MAX

- Same like MEC Tube II HR but with Block Max

M 18	M 22	
19907422	19907425	ANSCHÜTZ
19907522	19907525	FEINWERKBAU
19907622	19907625	WALTHER
19907722	19907725	STEYR

RRP in Euros: **315.00**



MEC STRIKE

- Two-part aluminium tube for smallbore rifles
- Individually made to the measurements of your barrel (supply with order)
- Continuous profile, variable sight-base
- Give muzzle diameter (25.76) and type when ordering

Strike

+ model + Barrel diameter

RRP in Euros: 219.00

MEC BERTA II

- 1 tube frame with 1 aluminium tube
- 14 cm, about 160 g (blue)
- Specify model (e.g. Anschütz 1913) and barrel diameter
- Easy cleaning and secure mounting
- Incl. alignment ring



Berta II

+ model + Barrel diameter

RRP in Euros: 219.00





MEC TUBE WEIGHT

- Additional weight stainless steel 30 g
- Fit to MEC Tube + MEC Tube II

5000094

RRP in Euros: 13.00



MEC BERTA WEIGHT

- 50 g
- Fitting with MEC Berta

5000099

RRP in Euros: 33.00



FRONT-SIGHT ELEVATION-SET

- Sight dovetail Duo for MEC tube II
- Without front sight tunnel

19907800

RRP in Euros: 69.00



DUO-RAIL

- Duo-base for Mec Tube II
- Also compatible with Score Crystal

19907801	M 18
19907802	M 22

RRP in Euros: 37.00

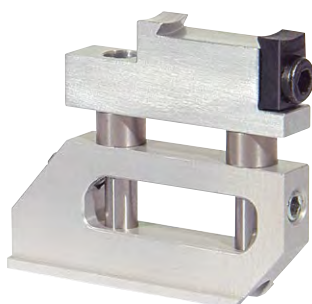

DUO-RAIL HR

- Front sight elevation for Duo front sights
- Duo-base for Mec Tube II
- Also compatible with Score Crystal

19907803	M 18
19907804	M 22

RRP in Euros: 83.00



DUO BASE HR

- Sight Elevation without front sight tunnel
- High 18 mm
- Variable in 1 mm steps to 27 mm

M 18	M 22	
19907805	19907809	ANSCHÜTZ
19907806	19907810	FEINWERKBAU
19907807	19907811	WALTHER
19907808	19907812	STEYR

RRP in Euros: 79.00



Shows Sight extension for MEC Berta II



SIGHT EXTENSION FOR MEC BERTA II

- Additional components for MEC Berta II
- Allows the extension of the target line
- Includes additional rod
- 20 cm, about 265 g (silver)

5000100

RRP in Euros: **55.00**

MEC BERTA KK - ALIGNMENT RING

- Alignment ring

5000098

RRP in Euros: **43.00**



1
2
3
4
5
6
7

MEC VISOR

- Cap made out of Neopren
- Feather light protection from Scattered light rays
- Can be formed in any desired way
- 2 colours, can be worn on either side

5000176

RRP in Euros: 12.00



COVER SET

- Made from dust-tight, water- and humidity-resistant, non-tear polyamide fabric
- Protection class IP65
- Set includes two separate covers – one for the front sight tunnel, the other for the rearsight

5011356

RRP in Euros: 55.00



COVER, REARSIGHT (without image)

- Adjustable rearsight cover for high-performance rearsight systems
- Outer dimensions approx. 150 mm (h) x 170 mm (l) x 45 mm (w)
- Long hook-and-loop closure tapes ensure the cover can be fitted straight or at an angle – as suitable for the size and height of the overall rearsight system – to various different custom-configured rearsight/sighting line/rifle stock systems

5011357

RRP in Euros: 29.00

COVER, FRONT SIGHT TUNNEL (without image)

- Adjustable front sight tunnel cover for high-performance front sight systems
- Outer dimensions approx. 100 mm (h) x 120 mm (l) with adjustable hook-and-loop closure. Fits to both small and large high-quality front sight systems
- Also protects the muzzle

5011358

RRP in Euros: 26.00

PROTECT TRANSPARENT / BLUE

- Plastic tube for storing cylinders
- Diameter: 3.5 cm
- Length-adjustable from 36 - 60 cm
- Accommodates a rifle cylinder
- Suitable for use with cylinders from all major air rifle manufacturers

5011351 . translucent
5011350 . blue

RRP in Euros: 5.90



Cylinder not included



1

2

3

4

5

6

7

MEC SWEAT BAND

- High quality cloth with velcro fastening
- Exchangeable towelling insert
- Includes cover trans with velcro fastening



5000185

RRP in Euros: 39.00



Shows Sweatband with MEC glas side blinds and MEC glas Cover 30 mm



MEC SWEAT BAND COMFORT

- 31200 Band incl. MEC glas cover 30 mm semitransparent
- 31201 Band incl. MEC glas side blinds / blinkers
- 31202 Band incl. MEC glas cover 30 mm semitransparent and MEC glas side blinds / blinkers

5030677

RRP in Euros: 55.00

5030676

RRP in Euros: 59.00

5030678

RRP in Euros: 79.00

FROTTIER-INLETT

- Toweling-Ticking for exchanging

5004050

RRP in Euros: 10.00



MEC STATIV

- Aluminium tripod for standing (and kneeling), can be broken down, in case
- With resting platform and adjustable accessory tray for tools and ammo
- Stable, high-quality finish with well thought-out adjustability
- Three separately adjustable feet, can be placed right at the balustrade
- Tubes in anodised aluminium, choice of colours when ordering
- Extendable to 190 cm, heavy enough for stability
- Tripod inclusive case

5009982	anthracite
5009983	blue
5009984	gold
5009985	lilac
5009986	red
5009987	black
5009988	silver

RRP in Euros: 239.00



Picture shows Qiang Yuan ammunition and the centra MEC Tin Clip

MEC BUTLER

- Extendable arm for the Stativ, four-sided alu-profile
- With fixing angle plate
- Allows free choice of placement for ammunition and tools for access in position

5000151

RRP in Euros: 34.00



MEC SPIDER

- High-quality tripod, aluminium
- The feet can be folded with a trick together
- Incl. adjustable ammo-holder
- Quality function and design for a reasonable price

5000157

RRP in Euros: 145.00



MEC AMMU-HOLDER

- Ammo-holder, easy to adjust at any tube
- Easy to turn in any direction

5000154

RRP in Euros: 21.00



MEC TRIPOD CLUB

- Aluminum construction, Light-weight
- Quick and easy set-up
- Adjustable to a maximum height of 150 cm
- Anti-slip rubber pad secures your the rifle while resting
- Multi-ammunition holder
- Nylon bag included

5018788	blue
5009989	green
5009990	gold
5009991	pink
5009992	black
5009993	silver

RRP in Euros: 140.00

1
2
3
4
5
6
7



FOR 3-POSITION



SHOOTINGBELT SLING

- Quality adjustment mechanism with buckles, fine tensioning, rotation and height regulation
- Parallel upper arm loop for self-adjusting pull
- Leather as the alternativ material

19960001

Sling-Fibre right

19960002

Sling-Fibre left

RRP in Euros: 199.00

19960005

Sling-Leather right

19960006

Sling-Leather left

RRP in Euros: 219.00



SHOOTINGBELT SLING STARTLINE

Economic simple version

- Parallel upper arm loop for self-adjustment pull
- Special bearing for self-adjustment of forearm-sling

19960003

right

19960004

left

RRP in Euros: 156.00



CONNECT

– Sling connect

19960010

RRP in Euros: 45.00



Without Band Fibre

CLUTCH

19960009

RRP in Euros: 34.00



Without Clutch

BAND FIBRE

19960008_K	with clutch
19960008	without clutch

RRP in Euros: 19.00



Without Clutch

BAND LEATHER

19960007_K	with clutch
19960007	without clutch

RRP in Euros: 36.00



BUCKLE FOR SLING

– Fixing element

19960011

RRP in Euros: 90.00



BI-POD

A rifle Bipod with

- Folding legs
- Anti slip rubber feet

19930002

RRP in Euros: 63.00



HANDSTOP

- Individually adjustable hand stop
- Moveable on the side
 - Variable height elevation
 - Two possibilities for connecting the sling ring
 - Optimal form and function
 - Moves in the track without any tool
 - Can be offset

19913701

RRP in Euros: **109.00**



HANDSTOP STARTLINE

- For small and sensitive hands
- Optimal ergonomics
 - Small cross-section
 - Easy to use

19913703

RRP in Euros: **79.00**



MEC STOP HOLDER

5000108

RRP in Euros: **35.00**



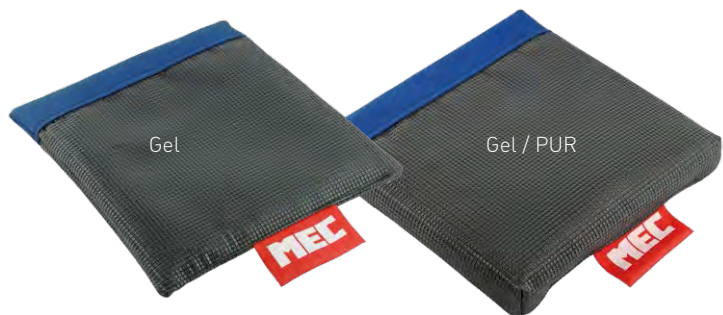

MEC PAD, 3 DESIGNS

- Pads for use in the kneeling position
- Available in three designs
- Non-slip outer ensures optimum hold when in stance
- Complies with ISSF regulations
- Dimensions: approx. 17 cm x 17 cm, height approx. 1.5 / 2.5 cm

5009977 . gel
5009978 . gel / PUR
5009979 . composite / PUR / cold foam

RRP in Euros: 49.00



MEC ACHILLES

- Kneeling roll with integrated foam mantle for pressure-reduction.
- Anti-stretch artificial fibre and adhesive cover
 - Stable support, noticeably reduced fatigue in the foot
 - Without filling

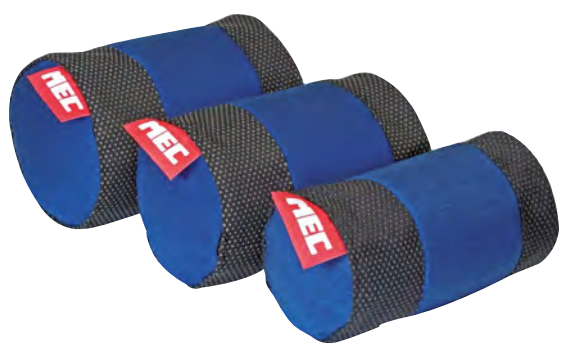

5009994	12 cm (Junior)
5009995	13 cm
5009996	15 cm

RRP in Euros: 69.00



FILLING

- Filling for kneeling roll 2 kg
- Enough for individuell filing

5000169

RRP in Euros: 12.00



CHAMPION

Palmrest

- Adjustable in all directions including barrel axis
- Palmpiece replaceable

19930003

RRP in Euros: 260.00



STABILIZER

- A Supplementary weight for Free Rifle
- Weight adjustable in all directions
- Can be supplied with
 - a) Carbon vibrationabsorber (220 g)
 - b) Steelrod with two extra weights (230 g)

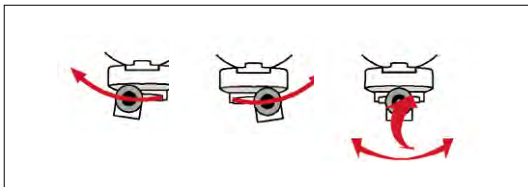

19930004

Carbon

RRP in Euros: 260.00

19930005

Steel

RRP in Euros: 229.00





Please provide the following information when ordering:
Left or right-handed design

VIBRAKE

Action-Stabilator

- More Stability of the action in the area of loading cutout
- Improvement of the group
- Line of sight 8 mm higher like a 8 mm riser block
- Possibility for side mount (Redfield) of the rear sight
- Weight: 110 g

Vibrake	
19930030	ANSCHÜTZ
19930040	FEINWERKBAU
19930050	WALTHER

RRP in Euros: 170.00

Incl. front-sight elevation

19930031	ANSCHÜTZ
19930041	FEINWERKBAU
19930051	WALTHER

RRP in Euros: 179.00

For Rearsights with Redfield-mount

19930061	ANSCHÜTZ
19930071	FEINWERKBAU
19930081	WALTHER

RRP in Euros: 179.00



VIBRAKE EXTENT

- Analog to Vibrake, but extended model to mount scopes

19930060	ANSCHÜTZ
19930070	FEINWERKBAU
19930080	WALTHER

RRP in Euros: 189.00



MEC GLOBE

For the bolt handle on small bore rifles

- Anodised aluminium ball
- Lighter, easier to use, and better looking

5009998	FEINWERKBAU / WALTHER
5009997	ANSCHÜTZ

RRP in Euros: 39.00

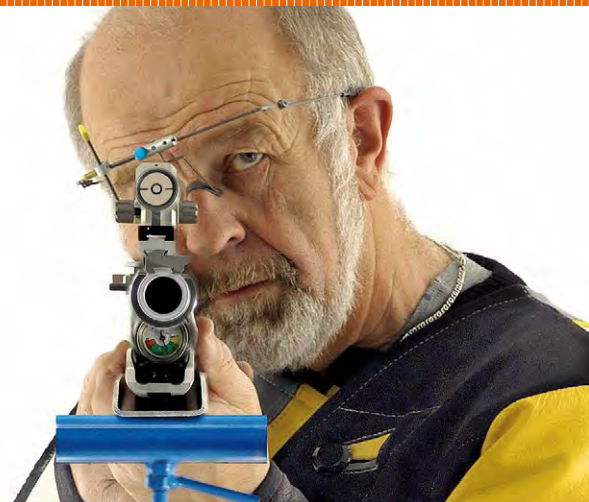

FOR SUPPORTED SHOOTING

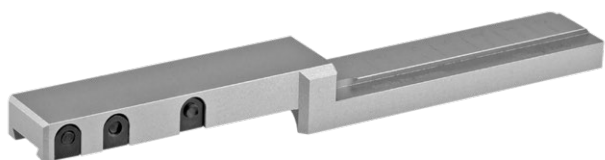

TELE

- Stepped block, brings the rear sight rearwards to the shoulder

19908001	ANSCHÜTZ
	WALTHER
	STEYR
	HÄMMERLI
19908002	FEINWERKBAU

RRP in Euros: **94.00**

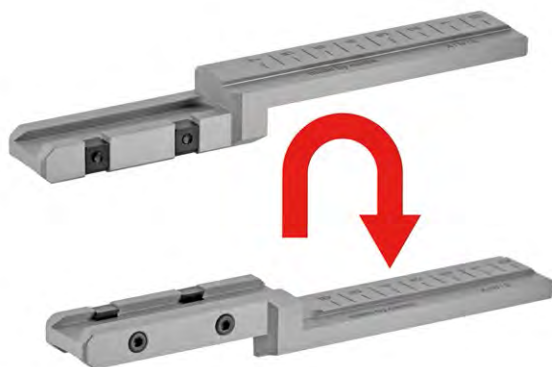

TELE HR

- Stepped block, brings the rear sight rearwards to the shoulder. Multifunctional, dovetails on both sides
- Integrated sight elevation 16 mm
- To combine with front-sight-elevation Block 16k

1990821	ANSCHÜTZ
	WALTHER
	STEYR
	HÄMMERLI
1990822	FEINWERKBAU

RRP in Euros: **115.00**

THESE NEW PRODUCTS

can be found on **page 14**.



centra Jack

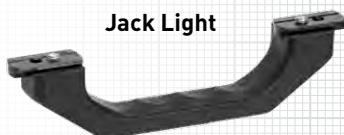

Jack Light

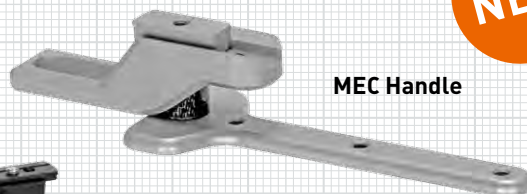

MEC Handle

NEW



BLOCK 16K

- To combine with Tele HR

19915916	ANSCHÜTZ
19915917	FEINWERKBAU
19915918	WALTHER
19915919	STEYR
19915920	HÄMMERLI

RRP in Euros: **41.00**

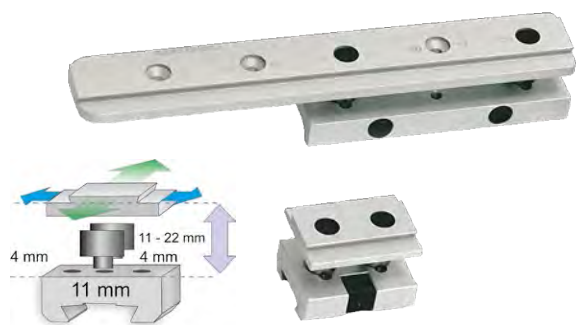

TELE FLIGHT

Multifunctional elevation

- Height and side adjustable
- Max height: 22 mm
- Min height: 11 mm
- Possible side adjustment 4 mm to the left and right
- Possibility to mount a scope

Complete	Diopter elevation	
1990826	1990832	ANSCHÜTZ
1990827	1990833	FEINWERKBAU
1990828	1990834	WALTHER
1990831	1990836	STEYR
1990830	1990835	HÄMMERLI

Complete

RRP in Euros: **120.00**

Diopter elevation

RRP in Euros: **80.00**



RACK

To stabilize the rifle if you shoot off a tri-pod

19915921	ANSCHÜTZ
	WALTHER

RRP in Euros: **77.00**



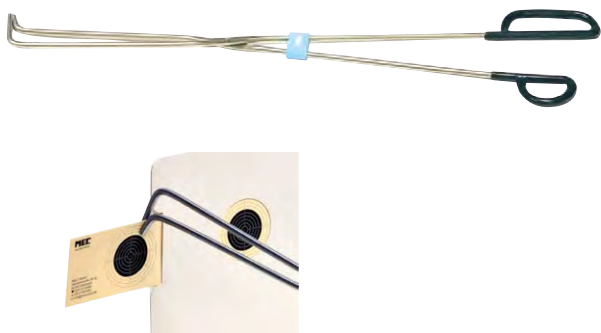

MEC GRIPPER

- Tongue to grasp single targets and target strips
- Extends your reach thus makes changing your target easier and allows the shooter to remain in his position
- Ideal for shooting a stand

5000190

RRP in Euros: 39.00

CATAMARAN II

- New support rail design
- Maximum precision due to milled rails
- Extremely low-profile design
- The aluminium bracket ensures level support and outstanding grip
- The height and width of the Catamaran are adjustable and it can also be rotated around the centre line of the bore (for canting)
- Compatible with all rifles that have a straight fore-end stock and accessory rail
- Material: Aluminium
- 280 mm long
- Variable width adjustment up to a maximum of 60 mm

standard



rotatable



rotation



5000646

standard

RRP in Euros: 159.00

5000743

rotatable

5000744

rotation

RRP in Euros: 229.00





BENCHREST DOCK

- Special designed chair for benchrest-shooting
- Adjustable height, without a tool
- Adjustable incline
- Possibility to take apart for transport
- Dock, the base for top results

19915925

RRP in Euros: 299.00



GERMAN

TEACHINGPOSTER AUFGELEGT SCHIESSEN

Heinz Reinkemeier, Peter Eckhardt, Helmut Heermann, Hans-Otto Raukohl.

DIN-A 1 (50 x 80 cm), August 2007, colour, with commentary.

Supported shooting is booming.

Poster, August 2007, 50 x 80 cm, colour, with detailed commentaries. Delivery folded to DIN A4 Format.

5000222

RRP in Euros: 3.00

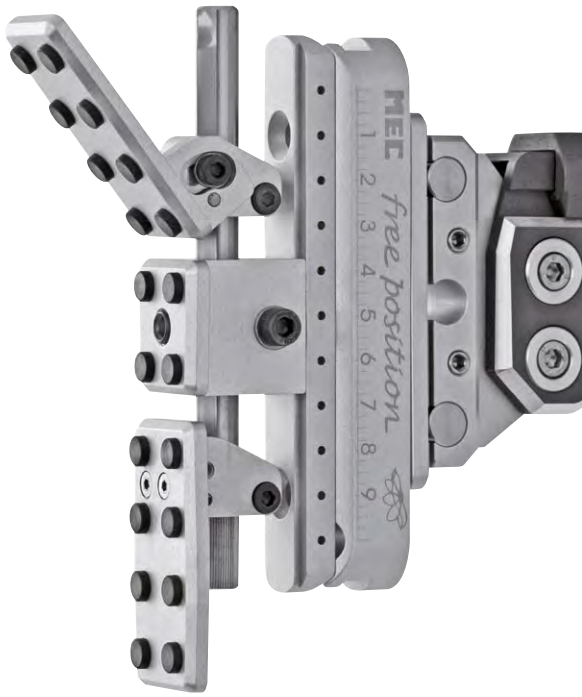

WHILE STOCKS LAST!

MEC FREE POSITION AGL

- Special butt plate for Benchrest Shooting
- Uncountable possibilities of variation
 - Specially adapted wing elements for benchrest shooter
 - Wing elements allow it to be placed up high, at an angle and rotate around the axle
 - Delivery without MEC Hook
 - Fits all current sport rifles

5000051

RRP in Euros: **249.00**



MEC FREE POSITION AGL - WING

- Retrofit wing for Free Position

5000052

RRP in Euros: **59.00**



COMFORT

- Rubber butt plate, ideal for benchrest shooting
- Special ergonomically designed
 - Fits all match grade rifles

19913901

RRP in Euros: **77.00**



HIGH END 2,6



- Available sizes: M18: 4.5-7.5 and M22: 4.5-10.0
- Ring width 2.6 mm
- Available only with clear glass



Order example for High End Circle, 2,6

Thread	Diameter	Ring width
M18 = 2	4.5 = 45	2.6 = 26
M22 = 5		

1	9	4	2	4	5	2	6	C	+ Colour C = clear
---	---	---	---	---	---	---	---	---	-----------------------

RRP in Euros: **22.00**



FOR PISTOLS



EYE BLINDER

– Available in: white, transparent and black

19901001	white
19901002	transparent
19901003	black

RRP in Euros: 27.00



IRIS FOR GLASSES

– Metal iris

19901006

RRP in Euros: 73.00



ADDITION L-FRAME 686

– Smith and Wesson six (6) shot revolver
forend counterbalance weights
– Total weight: 130 g

19930092

RRP in Euros: 119.00



CENTER 2

Rotating-sight for S&W Revolver
– 2 steps, for duell and precision
– Steel, antiglare-finish

19940010	width 3.2 mm
19940011	width 3.5 mm
19940012	width 4.0 mm

RRP in Euros: 75.00



DEVICE

Sight-sign for freepistol TOZ
 – Laser engraved sign for orientation

19930091

RRP in Euros: 37.00



ADD 30

Variable weightsystem for Steyr LP10
 – To optimize center of gravity and weight of pistol
 – Aluminium-rack and avariable high-grade steel weightblock
 – Weight: komplette system 60 g

19930020

RRP in Euros: 89.00

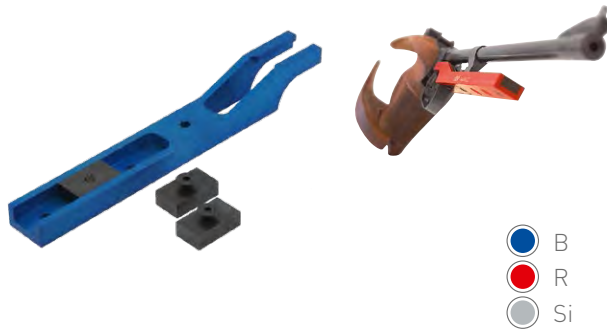

TOZ-BALANCE

Fore-end in high graded aluminium for Free Pistol TOZ
 – T2 Additional weight for individual Balance
 – Weight komplette: 155 g

19930090 + Farbe

RRP in Euros: 112.00

- B
- R
- Si

PUTTER

Trigger-lever with special geometry for Pistols
 – Wide, domed, sharp surface
 – Horizontal cut-out



19940049

STEYER

19940050

FEINWERKBAU

19940051

MORINI

RRP in Euros: 62.00

FOR EVERYONE



ROD

- Cleaning rod for highest claims
- Handle with multiple ball bearings
- Special non-abrasive plastics-coating to avoid damaging the bore
- Ergonomically designed wooden handle, greased

Long (88 cm)	Short (18,5 cm)	Caliber
19C00001	19C00011	5.6 mm (.22) – 6.5 mm (.264)
19C00002	19C00012	from 7 mm (.284)

RRP in Euros: 62.00



AIR-WEAPON CLEANING SET

- Rod with multiple bearings
- Special coated
- Ergonomic wooden grip
- Including rod guide and stopper
- For air-rifles and air pistols

19C00013

RRP in Euros: 83.00



GUIDE

Cleaning Rod Guide

- Prevent damaging of chamber
- Keep back oil and dirt from triggermechanism
- Synthetic

19C00201	FEINWERKBAU
19C00200	ANSCHÜTZ
19C00202	WALTHER

RRP in Euros: 29.00



LUBE

Aluminium container with special oil

- For cleaning the barrel and maintenace metal components

19C00100

RRP in Euros: 12.00

BRONZE-BRUSH

- New developed cleaning brush
- Very much short britles, very good cleaning
 - Brush have exact measure of caliber
 - No break off the britles

19C00021	5.6 mm / .22
19C00022	6 mm / .243
19C00023	6.5 mm / .264

RRP in Euros: 11.00

19C00024	7 mm / .284
19C00025	7.62 mm / .308
19C00026	8 mm / .323
19C00027	8.5 mm / .338
19C00028	9.3 mm / .366
19C00029	9.5 mm / .375
19C00030	10.75 mm / .423
19C00031	11.05 mm / .458

RRP in Euros: 13.00



CLEANINGSET-BARREL-TUNER

- Handle with cleaning brush
- Brush exchangeable
- Important accessory that helps you to maintain the precision of the barrel

19907826 + colour

RRP in Euros: 35.00



BIG-BRUSH

Replacement brush

19907827

RRP in Euros: 12.00



OUR NEW PRODUCT

Guide Bleiker

can be found on **page 23**.



NEW



BARREL CLEANER 4.0 – 4.5 mm

5011361	Quick-cleaning felt pellet 4.5	100 pcs.	RRP in Euros: 4.95
5011362	Quick-cleaning felt pellet 4.5	500 pcs.	RRP in Euros: 14.15
5011408	Barrel cleaner 4.5	100 pcs.	RRP in Euros: 6.40
5026217	Barrel cleaner 4.5	500 pcs.	RRP in Euros: 21.95
5011409	Super intensive 4.5	100 pcs.	RRP in Euros: 11.40
5011359	Match-Pocket-Set air rifle		RRP in Euros: 19.95



BARREL CLEANER .22

5011387	Barrel cleaner .22	80 pcs.	RRP in Euros: 6.40
5011388	Barrel cleaner .22	500 pcs.	RRP in Euros: 24.25
5011366	Super intensive .22	80 pcs.	RRP in Euros: 11.40
5011367	Super intensive .22	500 pcs.	RRP in Euros: 49.05
5011360	Firearm-Pocket-Set small bore		RRP in Euros: 19.95



BARREL CLEANER 6 mm

5011390	Barrel cleaner 6 mm	50 pcs.	RRP in Euros: 6.40
5011389	Barrel cleaner 6 mm	500 pcs.	RRP in Euros: 24.25
5011369	Superintensiv 6 mm	50 pcs.	RRP in Euros: 11.40



VFG PASTE / GREASE / OIL

5004084	Barrel cleaning paste	60 g	RRP in Euros: 15.45
5004085	Lupus Teflon grease	50 g	RRP in Euros: 15.25
5004086	Lupus Gun oil	50 ml	RRP in Euros: 16.65



ADAPTER

5011411	VFG adapter	adapter M5 out 1/8" in	RRP in Euros: 3.80	
5011415	For english cleaning rods	For example für Parker Hale From Caliber 6.5 mm	RRP in Euros: 3.80	
5011413	For english cleaning rods	For example für Parker Hale From Caliber 7 mm	RRP in Euros: 3.80	
5011416	For US cleaning rods	8 - 32 UNC-Threat	RRP in Euros: 3.80	
5011414	For US cleaning rods	7 - 32 UNC-Threat	RRP in Euros: 3.80	
5011410	For VFG cleaning rods Cal. 4 - 4.5 mm	adapter für VFG cleaning rods Caliber 4 - 4.5 mm	RRP in Euros: 4.30	
5011412	For swiss cleaning rods from Cal. 7.5		RRP in Euros: 3.80	



PUTZSTOCK

5015616	VFG cleaning rod, short, 280 mm	Incl. adapter 66803, 1-piece	RRP in Euros: 28.75	
5015615	VFG cleaning rod, long, 740 mm	Incl. adapter 66803, 1-piece	RRP in Euros: 32.90	
5015617	VFG cleaning rod, 1-piece	Wipe lenght 900 mm, 22 - 6.5 mm incl. adapter 66804	RRP in Euros: 29.65	
5015618	VFG cleaning rod, 3-piece	Wipe lenght 880 mm, 22 - 6.5 mm incl. adapter 66804	RRP in Euros: 34.20	

ADDITIONAL INFORMATION AND PRODUCTS

from our range of VFG items can be found at:

<http://shop.mec-shot.com/zubehor/all/weapon-cleaning/vfg.html>



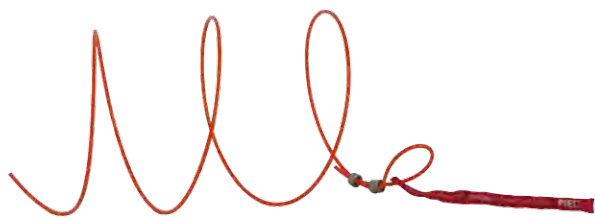

SAFETY NR

Safety flag for air rifle and air pistol

- For ISSF-competitions
- With stainless-steel ring to open and close the loop for fixing a personal thing like a mascot

19940083

RRP in Euros: **5.90**



Product example

SAFETY LOOK

Safety first!

- Synthetic cartridge with signal flag
- Give signal, there is no live cartridge in chamber
- No cooling down of barrel

19P00001	Caliber 4.5 mm (air-rifle / air-pistol)
19P00002	Caliber .22
19P00003	Caliber .32
19P00004	Caliber .38 / .357
19P00005	Caliber .44
19P00006	Caliber .45
19P00007	Caliber 6 mm / .308 Win / 30.06
19P00008	Caliber 6.5 x 55
19P00009	Caliber 8 x 57
19P00010	Caliber 7.5 x 55
19P00011	Caliber 12 / Schrot
19P00012	Caliber 9 Para

RRP in Euros: **5.90**



MEC SILENCE

- A silicon active membrane earplug
- Variable noise dapening
- Non skin allergic
- Made from breathable material
- A comfortable plug to wear

5000112

RRP in Euros: **36.00**

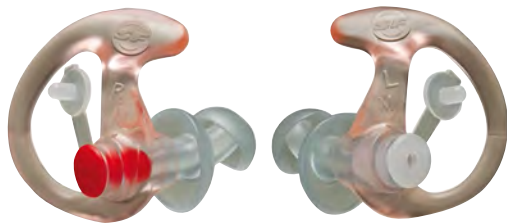

DEFENDERS HEARING PROTECTION

- A silicon active membrane earplug
- Size: S, M, L
- Variable noise dapening
- Non skin allergic
- Made from breathable material
- A comfortable plug to wear

5010080	Size S
5010081	Size M
5010082	Size L

RRP in Euros: **29.00**

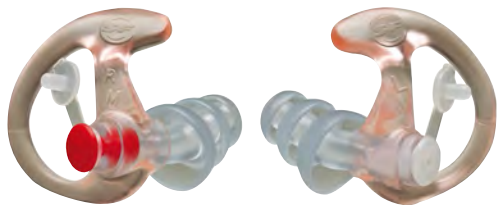

DEFENDERS HEARING PROTECTION PLUS

- A silicon active membrane earplug
- Size: M, L
- Variable noise dampening
- Non skin allergic
- Made from breathable material
- A comfortable plug to wear

5010083	Size M
5010084	Size L

RRP in Euros: **29.00**



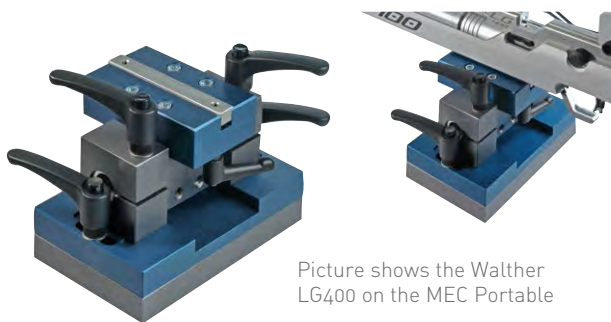

Picture shows the Walther LG400 on the MEC Portable

MEC PORTABLE

- Portable test bench
- Rotate, pivot and slope adjustments
- Strainless attachment in the t-nut profile rail
- Simple usable with out any tool

5000171

RRP in Euros: 539.00



Shows AP Mount on MEC Portable



MEC PORTABLE AP MOUNT

- Accessory for MEC Portable
- Mount compatible with all standard air pistols
- Pistols are clamped in place via their cylinder
- Easy to use, no tools required

5000173

RRP in Euros: 199.00

MEC PORTABLE SMALL-BORE MOUNT

- Test bench for small bore rifle
- Mount compatible with all standard competition rifles
- Easy to use, no tools required

5000175 . set without MEC Portable

RRP in Euros: 749.00

5000174 . complete set price

RRP in Euros: 1249.00

THESE NEW PRODUCTS

MEC Mat and **MEC Workbench Mat** can be found on **page 24**.

NEW

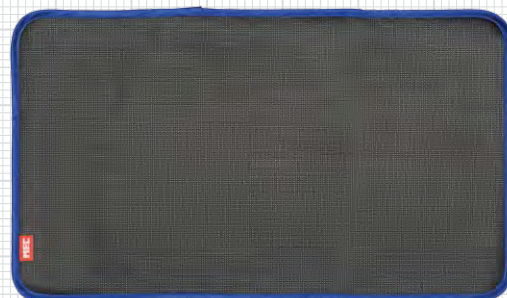
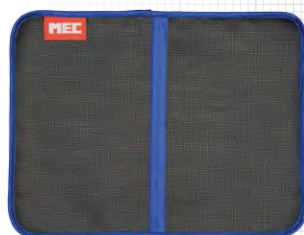

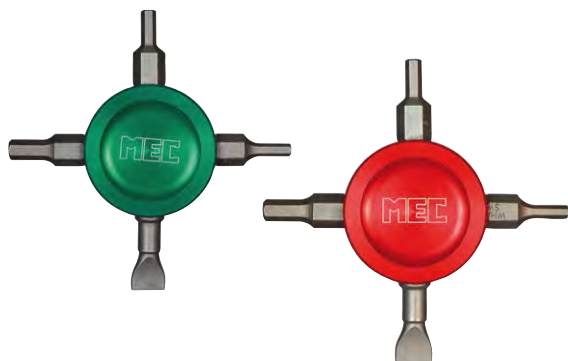

UNI-TOOL

- Suitable for common front sight tunnels, diopters, stock and hook caps, as well as handstops
- 4 tools: SW 2,5; SW 3,0; SW 4,0 and a blade

19A00001	Silver
19A00002	Black
19A00003	Blue
19A00004	Red
19A00005	Green

RRP in Euros: 18.50

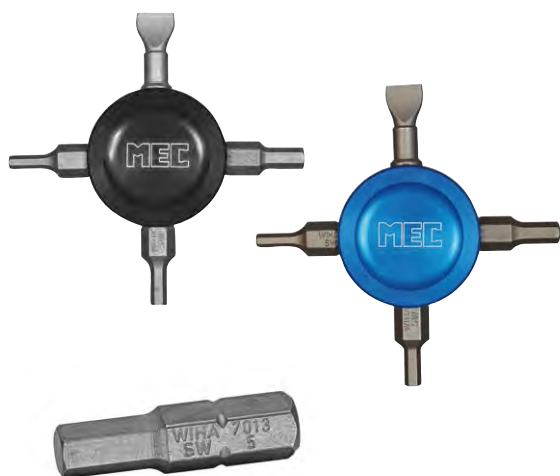

TOOL X

Like Uni Tool, but with one bit element being interchangeable

19A00031	Silver
19A00032	Black
19A00033	Blue
19A00034	Red
19A00035	Green

RRP in Euros: 22.00

19A00SW5	bit element
----------	-------------

RRP in Euros: 7.00



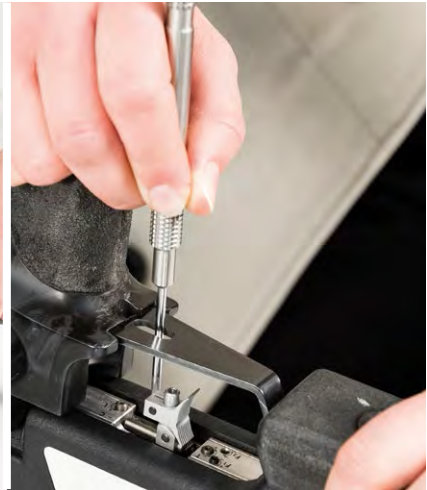

TORQUE



High-grade screwdriver for trigger adjustment

19A00000

RRP in Euros: 19.00



TORQUE TOOL II

NEW

Torque wrench

- Adjustment range from 3 to 15 Nm
- Supplied with shank bits in the following sizes:
 - 3, 4, 5, and 6 AF
 - Torx T25 and T30

19A1101

RRP in Euros: 99.00



TORQUE TOOL

- Precision-torque-tool
- Torque 1 – 20 nm

19A11000

RRP in Euros: 169.00



TRIGGER GAUGE

- Trigger-pull-gauge 25 – 250 g
- With drag-indicator

19A10000

RRP in Euros: 209.00



SLIDER RIFLE

Trigger-test-tool for rifles from 50 – 130 g

19A10002

RRP in Euros: 79.00



SLIDER PISTOL

Trigger-test-tool for pistols from 50 – 1100 g

19A10001

RRP in Euros: 109.00



MEC SPINDEL

- Gauge for the detection of double shots
- High quality manufacturing
- Coloured scale
- Manual

5009999

Cal. 22

RRP in Euros: 25.50

5010000

Cal. 32-45

RRP in Euros: 26.50

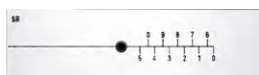

MEC NONIUS

- Gauge for the assessment of decimal values of shots on paper targets
- Plexiglas
- Manual

5010074

AR-Air Rifle

5010076

AP-Air Pistole

5010075

SR-Smallbore Rifle

5010077

FP-Free Pistole

5010078

RT-Running Target

5010079

RP-Rapid Fire

5004002

Set

Set

RRP in Euros: 46.00

RP

RRP in Euros: 12.00

AR, SR, FP, RT

RRP in Euros: 11.00



FRONT SIGHT BOX WOOD

- Novel wooden box, in laminated grey wood
- For 10 High End front sight inserts
- Available in M18 and M22

M18 . 19909000

M22 . 19909001

RRP in Euros: 51.00



NEW

MEC AIR RIFLE INSPECTION TEMPLATE

5018898

RRP in Euros: 52.00



MEC AIR PUCK

- Tin for 500 pellets
- Polished aluminium
- Airtight closure
- Without threading

5000114

RRP in Euros: 39.00



CASE

- Screw top alloy container to hold small items, Earplugs etc

19930001 + colour

RRP in Euros: 20.00



TIN CLIPS, CHINA AND STANDARD

- Clip for pellet tins
- Compatible with all standard tins
- Clip compatible with Qiang Yuan ammunition

5011354 . standard

RRP in Euros: 4.90

5011355 . China

RRP in Euros: 5.90



NEW

THESE NEW PRODUCTS

can be found on **page 21 and 23.**



Thermouche Underwear



MEC Classic Tin



PRECISE CONTROL

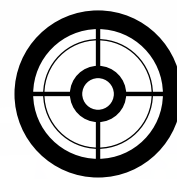

5 SCATT

- ⊙ SCATT SETS
- ⊙ SCATT ACCESSORIES
- ⊙ SENSOR FASTENERS

1

2

3

4

5

6

7



IVANA MAKSIMOVIC

2nd place 2012 Olympics



THE SCATT SYSTEM

Thanks to its lightweight sensor and outstanding program, the SCATT system is more than suitable for pistol shooters. More and more air pistol shooters are trying it out and training with SCATT at MEC in Dortmund.



The SCATT sensor weighs just 28 grams, making it a true lightweight among electronic trainers. With programs for the AP, FP, SP, RFP and many more disciplines besides, it is the leading system worldwide. Today, no really good coach works without an electronic trainer. It's time to find out more about computer-aided training – at the range and at home.



SCATT is an ideal tool for learning and monitoring the very delicate and technically complex aiming process. Aiming traces leave you in no doubt as to where your pistol was pointing at any one time, and playing back your shot also reveals every detail of the process. As a result, you can answer a lot of questions by experimenting: What size of front sight should I use? How wide should my rear sight be? What distance from the target centre produces the most accurate aiming processes? How long can I see the target image in sharp focus and when does my visual acuity start to deteriorate?

You can answer all these questions through experimentation, whether shooting live at the range or dry at home (from 4 metres!). Consistent dry firing exercises will give you confidence in your hold, aim and trigger release. The more often and longer you work with your pistol at home, the better your performance will be in live training and in matches. What's more, an electronic trainer will make your homework a lot more fun and a lot more efficient. And because you are practising under near-real conditions, it's much easier to stay motivated. The traces also show you what you're doing right and what you're doing wrong. Shooters can stabilise their strength, their muscle sensitivity and the consistency of their aim and trigger release at home – saving themselves time, travelling and ammunition.

Your aiming trace can also help you answer questions about your equipment: How much weight can I add to help me hold my gun more steadily? What balance will keep my recoil to an absolute minimum during the trigger release?

SCATT MX-02

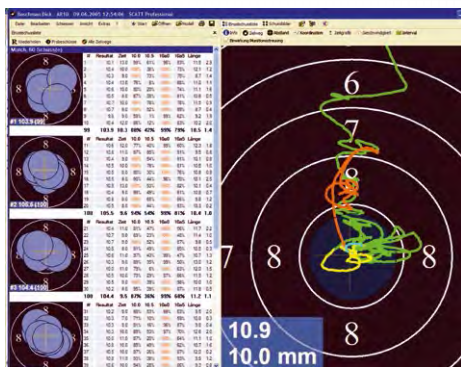

Several decades of highly skilled fine-tuning have resulted in a training system of unparalleled quality.

SCATT MX eliminates the need for hardware on the target. It is another leap forward. A paper target and a PC with a USB interface are all that you need.

Whether you are a beginner, advanced or professional shooter – if you can see your trigger release, you can improve it.

Tried-and-tested SCATTPRO software provides a unique mapping system for sophisticated analysis.

Only 36 g, from 3 – 300 m
– Live and dry

The ingenious attachment system fits virtually all diameters, whether round or rectangular.

Suitable for:

- Air rifles and pistols
- Small-bore rifles and pistols
- Full-bore rifles and pistols
- Bows

**LEARN FROM YOUR RIFLE,
LISTEN TO YOUR SCATT.**

1
2
3
4
5
6
7



Colours may vary from those shown.

SCATT MX-02 UNIVERSAL

Training system for static targets

- System suitable for dry and live firing
- Designed for both indoor and outdoor use
- System works with all conventional targets and electronic scoring targets (such as Meyton, Sius-Ascor, Disag, Häring)
- No risk of damaging an expensive piece of equipment when training with ammunition

Scope of supply:

- MX-02 optical sensor for 10, 25 and 50 metres
- Mounting kit for the optical sensor
- Connecting cable

5000285

RRP in Euros: 1699.00

SCATT SETS



SCATT WS1 PROFESSIONAL

Computer-controlled aiming path analysis (infra-red system) for almost all sporting rifles and pistols. For home training (dry) and live firing with airguns.

Included in the system area:

- Measuring frame with insert for air rifle targets, exact measurement from 4 - 12 metres
- Connecting cable for the PC (also for the power supply), Processor with connecting cable
- Wireless Sensor (only ca. 30 g) with USB charging cable and 5 fixing bands for all barrel diameters
- Programme on CD, handbook and installation instructions

- Clear menu structure, easy calibration
- No 25 / 50 metre target accessories available

Minimum system requirement:

Menu-driven through Windows, wide-ranging data processing and storage
 Minimum system requirement:
 IBM-compatible PC, 350 MHz processor or higher, 32 MB RAM, CD-ROM drive, SVGA monitor (800 x 600 16-bit colour), 2 free USB ports. Windows: 98, 2000, ME, XP, Vista, Win 7, Win 8. Internet Explorer 4.01 or later version.

5000272

RRP in Euros: 1349.00



SCATT USB PROFESSIONAL

Computer-controlled aiming path analysis (infra-red system) for almost all sporting rifles and pistols. For home training (dry) and live firing with airguns. Included in the system are:

- Measuring frame with insert for air rifle targets
- Connecting cable for the PC (also for the power supply)
- Processor with connecting cable
- Sensor (only ca. 30 g) with connecting cable and 5 fixing bands for all barrel diameters
- Programme on CD, handbook and installation instructions
- Exact measurement from 4 - 12 metres, easy to use

- Clear menu structure, easy calibration
- USB connection
- Menu-driven through Windows, wide-ranging data processing und storage

Minimum system requirement:

IBM-compatible PC, 350 MHz processor or higher, 32 MB RAM, CD-ROM drive, SVGA monitor (800 x 600, 16bit colour), 2 free USB ports. Windows: 98, 2000, ME, XP, Vista, Win 7, Win 8. Internet Explorer 4.01 or later version.

5000274

RRP in Euros: 1099.00



SCATT USB PROFESSIONAL BIATHLON

National teams, beginners and improvers all train with Scatt USB Biathlon. 5 shots with aiming path, 'sound' and further details concerning hold, aim and release can be recorded / displayed. In the club or in the garden at home, you can realistically and precisely rehearse the many fine points of sequential shooting at falling-plate

targets. Guaranteed fun for all who want to have a go, but also an unforgiving training partner for the best professionals.

5000311 . USB

RRP in Euros: 1199.00

5000312 . Wireless

RRP in Euros: 1399.00

SCATT ACCESSORIES



SCATT USB BIATHLON-TARGET

The 5-shot frame on its own, as an extra to an existing Scatt USB professional. Can be simply connected and driven with the standard software.

Biathlon is in trend, who wouldn't want to learn how to flatten 5 targets in double-quick time? A blessing for youth leaders, club presentations, children's birthdays and christmas shoots. In combination, for example, with our self-loading Scatt-rifle.

5000294 . USB

5000312 . Wireless

RRP in Euros: 589.00



SCATT TRIGGER SENSOR WTS

- Pressure sensor on the trigger
- Obtain information about the effort which the shooter presses the trigger
- The sensor made as a trigger with detachable cable, which attached to sport weapons instead of regular
- Trigger sensor connected to USB port of WS-03 optical sensor
- Information from the pressure sensor graphically displayed in a SCATT software window
- Connects to the control unit. Valid rod diameter for mounting the trigger is from 2 - 5 mm



5010066	WTS-TRR	round
5010067	WTS-TRL	round for left-handers
5010068	WTS-TSR	straight
5010069	WTS-TSL	straight for left-handers

RRP in Euros: 265.00



SCATT TRIGGER SENSOR STS

- Pressure sensor on the trigger
- Obtain information about the effort which the shooter presses the trigger
- The sensor made as a trigger with detachable cable, which attached to sport weapons instead of regular
- Trigger sensor connected to USB port of OS-02 optical sensor
- Information from the pressure sensor graphically displayed in a SCATT software window
- Connects to the control unit. Valid rod diameter for mounting the trigger is from 2 - 5 mm



5010070	STS-TRR	round
5010071	STS-TRL	round for left-handers
5010072	STS-TSR	straight
5010073	STS-TSL	straight for left-handers

RRP in Euros: 295.00



SCATT SENSOR WS-M02 WIRELESS



- Model: WS-M01
- Fixed into barrel of 9 mm caliber pistol
- Highly accurately measures the weapons alignment during aiming and actuation of the trigger mechanism
- Optical sensor automatically measures the distance to the electronic target
- The program allows you to automatically calibrate the sensor
- Weight 6 g

5000260

RRP in Euros: **580.00**

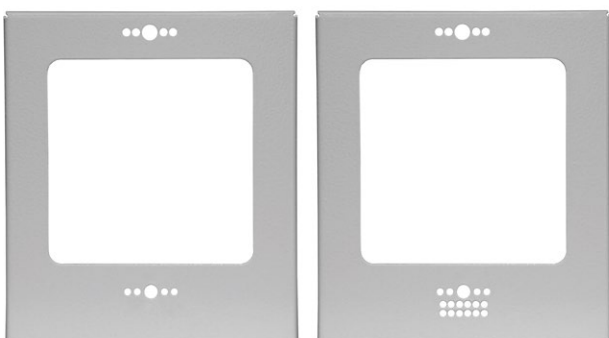

SCATT TARGET PROTECT

- 1.5 mm steel
- Powder-coated in colour light-grey
- Protects the frame against unwanted bullet hits and prevents bullet from bouncing back

5009980 . USB

5009981 . Wireless

RRP in Euros: **29.00**



SENSOR GUARD

Sensor-guard, metal strut designed to protect the Scatt-Sensor from unwanted contacts when the rifle is being rested. Fits in all profile rails.

5000309

RRP in Euros: 49.00

SCATT USB PULSE SENSOR

- A device allowing to obtain information about the frequency and moments of heart beats
- The sensor is designed as a wireless transmitter, fixed on the chest of shooter
- Data from the transmitter receives the control unit that connects to the USB port on your computer
- Information from the pulse sensor is displayed graphically in a shooting simulator window



5000278

RRP in Euros: 235.00

SCATT & NOTEBOOK CASE

- Bag for storing and transporting your Scatt and a Laptop computer (Notebooks up to 15")
- Dual metal zipper and velcro
- Scope of delivery: Bag with carrying handle and adjustable shoulder
- Colour: black
- Fits the Scatt USB and the Scatt USB und Scatt USB Biathlon



5002640

RRP in Euros: 36.00

Contents shown here are not included

OUR NEW PRODUCT

Locator can be found on **page 25**.

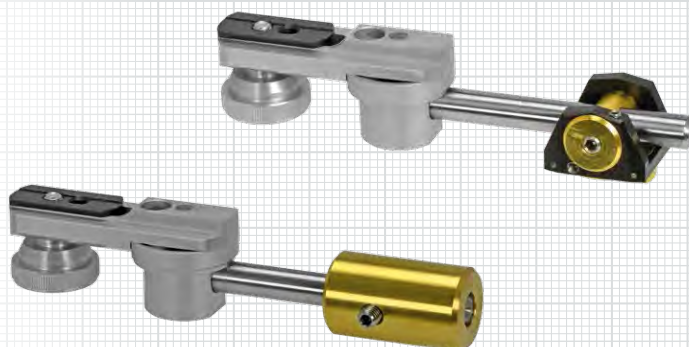

SENSOR FASTENERS



SCATT UNIVERSAL SENSOR MOUNT SET

- Includes allen key
- Mounting prism and metal strip with screw
- For fixing the sensor on the barrel of different diameters and cross sections

5000264

RRP in Euros: **36.00**



SCATT USB - BARREL HOLDER AR ALU D20

- Used to mounting the optical sensor on barrels of 20 mm. diameter
- Weight 12 g

5000246

RRP in Euros: **24.00**

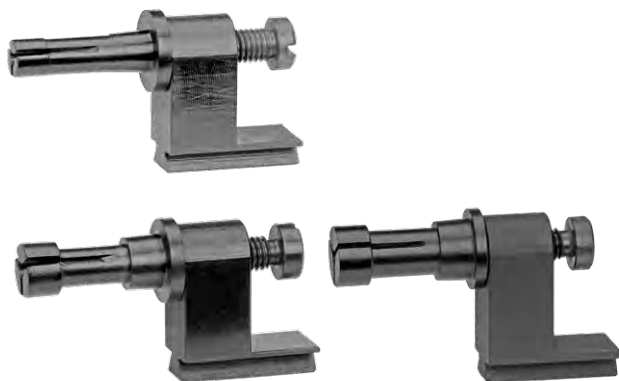

SCATT BARREL INSERTS

- Used to mounting the optical sensor on the short-guns
- Available in differnt calibers

5018314	caliber 22
5018315	caliber 30
5018316	caliber 35
5018317	caliber 45

RRP in Euros: **39.00**



SCATT BARREL ADAPTER BIATHLON

- Barrel adapter
- Are used to secure the optical sensor on the barrels less than 20 mm diameter

5010063	16 mm
5010064	18 mm
5010065	19 mm

RRP in Euros: **22.50**

Product Example

EXPERT KNOWLEDGE



6 LITERATURE

- ⊙ ENGLISH LITERATURE
- ⊙ OTHER LANGUAGES

- 1
- 2
- 3
- 4
- 5
- 6
- 7



PETRA ZUBLASING
LG World Champion 2014



LITERATURE AND MORE

In terms of technique and technology, shooting is one of the most complex sports. It takes years and decades to get to grips with all the details of shooting position, aiming and the trigger release. However, shooters can considerably reduce this time by getting access to the right information structured in the right way. And that's where an instructional book is still the best solution.

We have been designing and producing instructional books for shooters for 30 years. We currently have 6 German-language titles in publication that cover a range of topics such as air rifle shooting, smallbore shooting and the psychological aspects of shooting (and golf). A growing number of our books are also being translated into English and other languages. For example, hot off the press is our latest edition of "Air Rifle Shooting" – now published under the title "Air Rifle – Training and Competition".



Instructional posters are another method used to provide information quickly and concisely. Designing and producing a good instructional poster is a particularly challenging task. It has to present all the relevant information in a very limited space. Most important are clear pictures and drawings that provide a clear depiction of the main points at a glance. The pictures are accompanied by short texts that explain further details. Finally, the poster needs to work as one cohesive piece, so that it looks good on the wall at the club.

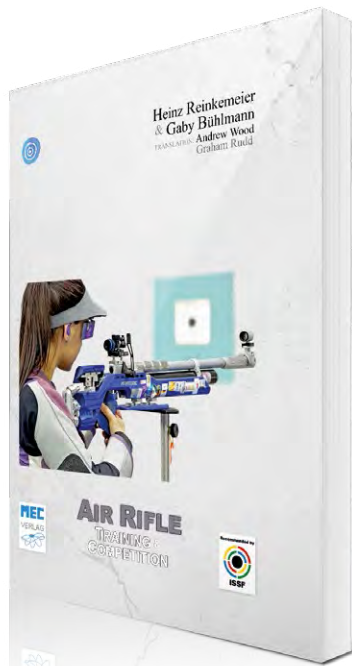

Air Rifle Training & Competition
English edition



Pistol Shooting
Polish edition

heinz reinkemeier



Further information on books by
Heinz Reinkemeier can be found here:

WWW.HEINZREINKEMEIER.DE

AUTHORS

Endless debate and weighty discussions are characteristics of the way our books come into being. The fact that we finally still manage to bring them to print speaks for a willingness to compromise which still somehow keeps on functioning even after long years of working together. The basic rule? Gaby always gets her own way...



HEINZ REINKEMEIER, Diploma in Psychology, coach, author and designer. Has written 7 books on the subject of target shooting, made several videos and published articles in a number of sport-related magazines.



GABY BÜHLMANN, Diploma in Psychology and coach. European Champion 1997, competed at the Olympics from '88 - '04. Among the athletes she coaches are air rifle world champion Abhinav Bindra, Olympic silver medallist Valentina Turisini and the Italian national team.



MAIK ECKHARDT, Businessman. Olympic athlete '96 - '04; fourth (prone) in Sydney, fifth (air rifle) and sixth (prone) in Athens. 04. Co-owner and managing director of MEC.

1

2

3

4

5

6

7



WAYS OF THE RIFLE

The standard work on rifle shooting. Includes all details of the 3 positions and the movement sequences. Action pictures of many current top shooters. English translation by Bill Murray. Since 1996 this book serves as essential reading for switched-on shooters and coaches at home and abroad. Translated into several languages. Belongs in every rifle cabinet...

More than 1000 photos and graphics.

Gaby Bühlmann, Heinz Reinkemeier, Maik Eckhardt

ISBN 3-98-097461-8

5000192

RRP in Euros: 44.80



PISTOL SHOOTING

All you need to know about the sport of pistol shooting. 1st English edition, 2013, 224 pages, colour, over 1,200 photos, illustrations and graphics. Includes pictures of top international athletes in action and detailed studio shoots with experts including world champion sport pistol shooter Munkhbayar Dorjsuren, Olympic free pistol champion Uwe Potteck and three-times Olympic RFP champion Ralf Schumann.

Contributions from German national coaches Peter Kraneis and Barbara Georgi and 17 other outstanding trainers and shooters from around the world. A detailed presentation of all the relevant aspects of training and competition. Divided into sections on technique (precision and rapid-fire), training, tactics, psychological factors and guns. Other topics include the German national league, youth training, supported air pistol, aiming path systems, ammunition testing, mental training, coaching, etc. Theory and practical recommendations and exercises are covered for each topic. A book for shooters at all levels, trainers, coaches and all pistol shooting enthusiasts.

Gaby Bühlmann, Heinz Reinkemeier

5000204 . ISBN 978-3-9814287-2-8

RRP in Euros: 49.90

OUR NEW BOOKS

can be found on **page 27**.



NEW



1
2
3
4
5
6
7

PERFORMANCE PLANNING 2010

The classic record-book for results, settings and performance statistics. With year planners, instructions and the most important pictures relevant to the positions. Performance planning and recording in a practical spiral-bound book. For participants and coaches who are fed up with working unsystematically.

From us to you in top quality, modern form and at an unbeatable price!!

August 2007, 128 pages, colour, spiral bound.

Bühlmann, Reinkemeier, Eckhardt

ISBN 3-9809746-8-4

5000198

RRP in Euros: 11.90



A SHOT AT HISTORY

My Obsessive Journey to Olympic Gold

The story of a man who fought valiantly to make his own history. Abhinav Bindra is India's first and only individual Olympic gold medallist and also the first Indian to win a World Championship.

2nd print edition,
ISBN 978-93-5116-070-0

5000203

RRP in Euros: 21.90

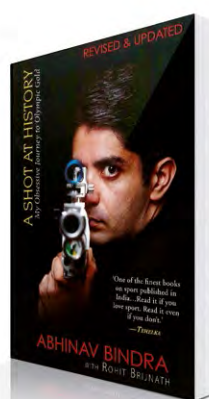

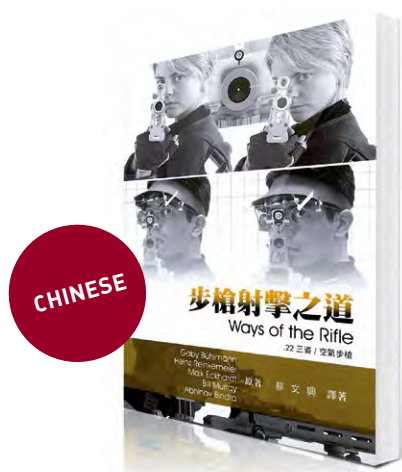

WAYS OF THE RIFLE, CHINESE

Gaby Bühlmann, Heinz Reinkemeier, Maik Eckhardt

The standard work for rifle shooting – now also available in Chinese. All the details on the three positions and movement sequences are covered over 441 pages. Many of today's top shooters are shown in action. Essential reading for committed shooters and trainers around the world since 1996.

No rifle cabinet is complete without it...

1st Chinese edition . ISBN 978-957-43085-0-7

5000205

RRP in Euros: 44.80

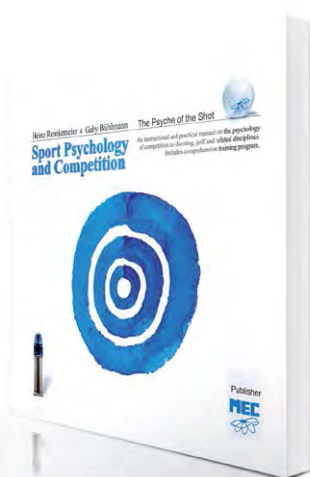

THE PSYCHE OF THE SHOT

Sport Psychology and Competition

In decisive moments, it's our psyche that tips the balance. Whether you achieve your goal or not is dependent on your thoughts and feelings, and on your behavior most of all.

This book is a guide to how you can systematically prepare for tournaments and other stressful moments. It contains 1,000 pictures, 200 exercises, a 6-week training plan and audio files on the techniques of psychological regulation.

Gaby Bühlmann, Heinz Reinkemeier

ISBN 978-3-9814287-1-1

5000202

RRP in Euros: 39.80



CD RELAX PROGRAM FOR ATHLETES

Audio-CD with Training Plan

First edition August 2005

Five exercise sequences for relaxation over a total of 90 minutes, with training plan.

The updated version of the legendary tapes from the 80s. Generations of shooters have learned muscular, autogenic and breathing relaxation from these exercises. Two further exercises with synthetic soundrhythms create relaxation and arousal. This CD has been used successfully in clinics and therapeutical practices as well as for all-round use in daily life.

Gaby Bühlmann, Heinz Reinkemeier

5000221 . ISBN 3-9809746-5-0

RRP in Euros: 19.90



1

2

3

4

5

6

7

TASTY EXTRAS

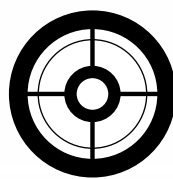

7 MERCHANDISE

⦿ JACKETS

⦿ HOODY

1

2

3

4

5

6

7



SABRINA SENA

World Cup winner in 2014 3X20



MEC WOMENS SOFTSHELL JACKET

- Women's fit
- With MEC and Centra logo imprints
- Available in white with black imprint
- Available with rifle or pistol imprint
- Sizes: S - XXXL

	Rifle	Pistol
Size S	5010031	5010025
Size M	5010032	5010026
Size L	5010033	5010027
Size XL	5010034	5010028
Size XXL	5010035	5010029
Size XXXL	5010036	5010030

RRP in Euros: **105.00**



MEC MENS SOFTSHELL JACKET

- Men's fit
- With MEC and Centra logo imprints
- Available in light blue with blue imprint
- Available with rifle or pistol imprint
- Sizes: S - XXXXL

	Rifle	Pistol
Size S	5010018	5010011
Size M	5010019	5010012
Size L	5010020	5010013
Size XL	5010021	5010014
Size XXL	5010022	5010015
Size XXXL	5010023	5010016
Size XXXXL	5010024	5010017

RRP in Euros: **105.00**



MEC WOMENS SOFTSHELL JACKET

- With printed MEC and centra logos
- Available in white with light-blue motif
- Detachable hood
- Cut to hug the waist
- Available with rifle or pistol motif
- Sizes: S - XXL
- **Please note:** Jacket sizes tend to be smaller than standard

	Rifle	Pistol
Size S	5010042	5010037
Size M	5010043	5010038
Size L	5010044	5010039
Size XL	5010045	5010040
Size XXL	5010046	5010041

RRP in Euros: **105.00**



HOODY

- Hood-jacket, lined
- Material: 45 % Cotton, 55 % Polyester

	Women	Men
Size S	5010006	5010001
Size M	5010007	5010002
Size L	5010008	5010003
Size XL	5010009	5010004
Size XXL	5010010	5010005
Size XXXL	-	5018789

RRP in Euros: **80.00**





*Letting go of the old to discover the new
reflects our natural rhythm.*



centra
Feinwerktechnik GmbH
Nägelestraße 15
79618 Rheinfeldern
Germany

Orders
Tel. +49 7623 749 120
Fax +49 7623 749 1249
info@centra-visier.de
www.centra-visier.de

MEC
H.T.S.E. GmbH
Hannöversche Straße 22
44143 Dortmund
Germany

Orders
Tel. +49 231 426 048-0
Fax +49 231 426 048-99
order@mec-shot.de
<http://shop.mec-shot.de>
www.mec-shot.de



facebook.com/mechtse